

# **OPERATION MANUAL**

## **METER FOR ELECTRICAL INSTALLATION PARAMETERS**

**MPI-505**

MPI-505 digital meter is designed to measure fault loop resistance, RCD parameters, insulation resistance, continuity of protective conductors, low-voltage measurement of low resistances and test phase sequences.

The most important features of MPI-505 include:

- Measurement of fault loop parameters:
  - ✍ impedance measurement with 23A current at 230V, maximum 44A at 440V ( $R=10\Omega$ ),
  - ✍ option for measuring in the phase-to-phase, phase-to-PE and phase-to-neutral short circuit, automatic calculation of short circuit current,
  - ✍ distinguishing between phase-to-neutral and phase-to-phase voltage during the short circuit current calculations,
  - ✍ measurements in mains with the following rated voltages: 115V/200V, 220/380V, 230V/400V and 240V/415V frequency range 45...65Hz (test voltage range: 100...440V),
  - ✍ selection of nominal voltage 115V/200V, 220/380V, 230V/400V or 240/415V,
  - ✍ measurement of fault loop impedance in the systems protected by RCD's without tripping RCD of  $0.01\Omega$  resolution, 0.01,
  - ✍ measurement of AC voltages,
  - ✍ quick check of the correct connection of PE conductor with the touch electrode.
  
- Testing RCD's of AC and A type:
  - ✍ function of auto-measurement for RCD parameters,
  - ✍ the waveform of forced leakage current selected by the user: sinusoidal (start at the rising or falling edge), pulsating unidirectional (positive or negative),
  - ✍ measurement of normal and selective RCD's with rated differential currents of 10, 30, 100, 300, 500 and 1000 mA,
  - ✍ measurement of RCD tripping current using rising current,
  - ✍ tripping time measurements at  $0.5 I_{\Delta n}$ ,  $1 I_{\Delta n}$ ,  $2 I_{\Delta n}$  and  $5 I_{\Delta n}$  current,
  - ✍ touch voltage measurement,
  - ✍ measurement of earth resistance,
  - ✍ option for measuring touch voltage and earth resistance without RCD tripping,
  - ✍ quick check of the correct connection of the PE lead using the touch electrode,
  - ✍ option for choosing RCD tripping -voltage to protect the system against exceeding safe voltage at 25 and 50V levels and additionally for selective RCD's at 12.5V,
  - ✍ option for simultaneous measurement of  $I_{\Delta}$  and  $t_{\Delta}$ .
  
- Measurement of insulation resistance:
  - ✍ four test voltages: 100V, 250V, 500V and 1000V,
  - ✍ measurement of insulation resistance up to  $3G\Omega$ ,
  - ✍ automatic discharge of the capacitance of tested object after the insulation resistance measurement is completed,
  - ✍ acoustic indication of five-second intervals to facilitate capturing time parameters for insulation resistance measurements.
  
- Low-voltage measurement of resistance:
  - ✍ low-current measurement of resistance with activated beep,
  - ✍ continuity test for the protection conductor with 200mA current for both polarizations of the test current.
  
- Checking sequence of phases.
  
- Other:
  - ✍ automatic selection of measuring range,
  - ✍ memory of 3500 individual measurement results with the option for data transfer to a PC via USB,
  - ✍ large, readable display with backlight option,
  - ✍ monitoring of the battery charge status,
  - ✍ AUTO-OFF function,
  - ✍ ergonomic operation,
  - ✍ possibility of power supply from rechargeable batteries.

# VIEW FROM THE TERMINALS

## Main measuring terminal

Terminal for connecting test leads during the measurements of fault loop impedance, RCD's, low voltage resistance measurement, testing circuit continuity and checking phase sequence.

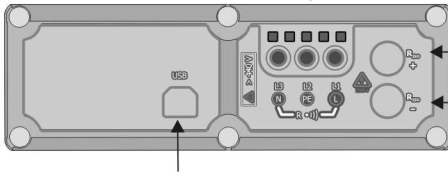

High voltage converter output for insulation resistance measurements.

## R<sub>iso</sub> measurement terminal

Terminal for connecting zero lead during insulation resistance measurements.

## USB socket

Socket for connecting a data cable to your computer.

# MPI-505

Power on/off. After the meter is turned ON, the display shows all digits and symbols (display test).

Starting the measurement procedure.

Touch electrode for testing the connection of PE conductor in the socket.

Approving selected option. When measurement is completed:

- activating the memory storing mode
- in the memory storing mode - saving the measurement result to a chosen cell.

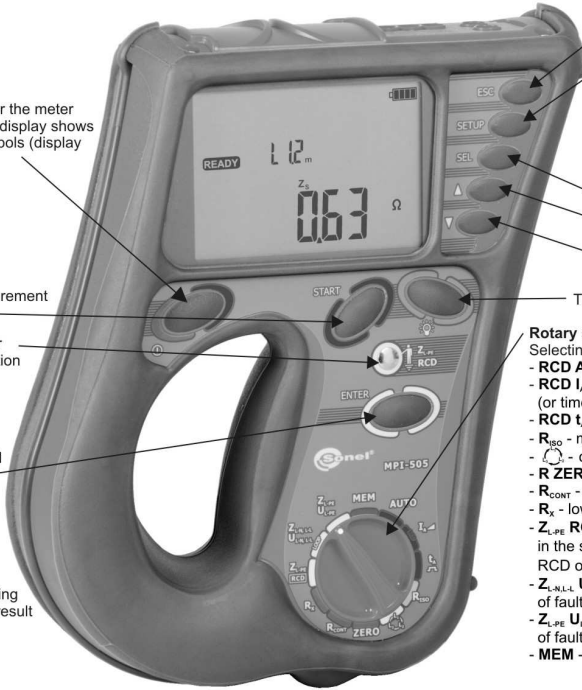

Exit the function. Back to previous screen.

Selection of measurement parameters in individual functions. After turning the meter on with the button kept depressed - selection of general measurement parameters:

- nominal mains voltage,
- parameters measured in RCD AUTO mode,
- Auto-OFF (on/off).

Viewing components of the measurement result. Increasing the value of chosen parameter (when depressed the action is automatically repeated) Decreasing the value of chosen parameter (when depressed the action is automatically repeated).

Turning the display backlight on/off.

## Rotary switch of function selection

- Selecting the measurement function:
- **RCD AUTO** - automatic measurement of RCD parameters,
  - **RCD I<sub>n</sub>** - measurement of RCD tripping current (or time - alternatively),
  - **RCD t<sub>x</sub>** - measurement of RCD tripping time,
  - **R<sub>BO</sub>** - measurement of insulation resistance,
  - **⊖** - checking sequence of phases,
  - **R ZERO** - compensation (zeroing) of leads resistance,
  - **R<sub>CONT</sub>** - measurement of circuit continuity,
  - **R<sub>x</sub>** - low-voltage measurement of resistance,
  - **Z<sub>L-PE RCD</sub>** - measurement of fault loop impedance in the systems protected by RCD's without tripping RCD of I<sub>n</sub> ≥ 30mA,
  - **Z<sub>N-L-L</sub> U<sub>N-L-L</sub>** - voltage and impedance measurement of fault loop in phase-to-zero or phase-to-phase circuit,
  - **Z<sub>L-PE</sub> U<sub>L-PE</sub>** - voltage and impedance measurement of fault loop in phase-protective circuit,
  - **MEM** - viewing memory data.

## DISPLAY

Parameter configuration mode active.

Signalling the presence of high-voltage on  $U_{BO}$  terminals.

Additional reading field.

Units of values displayed on the additional field.

Memory bank and memory cell number.

Memory storing or memory viewing mode active.

Battery charge status.

Warning - important error message displayed, read the operating manual.

Field for displaying incorrect voltage values:

- L-PE! - no  $U_{L-PE}$  voltage,
- L-N! - no  $U_{L-N}$  voltage,
- PE! - conductor PE is not connected.

Information on completed measurement of a RCD parameter in AUTO mode (MEM function).

Information on completed compensation of test leads resistance.

Field for displaying current waveform  $I_{sn}$ .

- ∧ - sinusoidal current with positive initial phase,
- ∨ - sinusoidal current with negative initial phase,
- ⌋ - unidirectional pulsating current with positive polarity,
- ⌋ - unidirectional pulsating current with negative polarity.

Values displayed on the main field.

Main reading field.

Units of values displayed on the main field.

Multiplication factor of  $I_{sn}$ .

Interference voltage causing additional measurement uncertainty.

Indication of current limiting during  $R_{BO}$  measurement.

L and N leads swapped.

RCD type (selective / standard).

Maximum touch voltage.

Values displayed on the main field.

Main reading field.

Units of values displayed on the main field.



## **OPERATING MANUAL**

# **METER FOR ELECTRICAL INSTALLATION PARAMETERS MPI-505**



**SONEL SA  
ul. Wokulskiego 11  
58-100 Świdnica**

Version 1.05 27.04.2017

The MPI-505 meter is a modern, easy and safe measuring device. Please acquaint yourself with the present manual in order to avoid measuring errors and prevent possible problems related to operation of the meter.

## CONTENTS

<b>1</b>	<b>SAFETY .....</b>	<b>5</b>
<b>2</b>	<b>MEASUREMENTS.....</b>	<b>6</b>
2.1	SELECTION OF GENERAL MEASUREMENT PARAMETERS .....	6
2.2	REMEMBERING THE LAST MEASUREMENT RESULT .....	7
2.3	MEASUREMENT OF ALTERNATING VOLTAGE (AC) .....	7
2.4	CHECKING THE CORRECTNESS OF PE (PROTECTIVE EARTH) CONNECTIONS .....	8
2.5	MEASUREMENT OF FAULT LOOP PARAMETERS .....	8
2.5.1	<i>Selection of measurement parameters .....</i>	<i>9</i>
2.5.2	<i>Prospective short-circuit current.....</i>	<i>9</i>
2.5.3	<i>Measurement of fault loop parameters in the L-N and L-L circuits .....</i>	<i>10</i>
2.5.4	<i>Measurement of fault loop parameters in the L-PE circuit .....</i>	<i>13</i>
2.5.5	<i>Measurement of short circuit loop impedance in L-PE circuit protected with a residual current device (RCD).....</i>	<i>14</i>
2.6	MEASUREMENT OF RCD PARAMETERS .....	16
2.6.1	<i>Measurement of RCD disconnection current.....</i>	<i>16</i>
2.6.2	<i>Measurement of RCD disconnection time.....</i>	<i>19</i>
2.6.3	<i>Automatic measurement of RCD parameters.....</i>	<i>21</i>
2.7	MEASUREMENT OF INSULATION RESISTANCE .....	25
2.7.1	<i>Measurement of insulation resistance of individual objects .....</i>	<i>25</i>
2.7.2	<i>Additional Information .....</i>	<i>27</i>
2.8	LOW-VOLTAGE MEASUREMENT OF RESISTANCE .....	28
2.8.1	<i>Measurement of continuity of protective conductors and equipotential bondings with <math>\pm 200</math> mA current .....</i>	<i>28</i>
2.8.2	<i>Low-current measurement of resistance.....</i>	<i>30</i>
2.8.3	<i>Compensation of test leads resistance - autozeroing.....</i>	<i>31</i>
2.9	CHECKING SEQUENCE OF PHASES .....	33
<b>3</b>	<b>MEMORY OF MEASUREMENT RESULTS.....</b>	<b>34</b>
3.1	STORING THE MEASUREMENT RESULT DATA IN THE MEMORY .....	34
3.2	CHANGING THE CELL AND BANK NUMBER .....	36
3.3	VIEWING MEMORY DATA.....	37
3.4	DELETING MEMORY DATA.....	39
3.4.1	<i>Deleting bank data.....</i>	<i>39</i>
3.4.2	<i>Deleting the whole memory .....</i>	<i>40</i>
3.5	COMMUNICATION WITH A COMPUTER .....	41
3.5.1	<i>Computer connection accessories .....</i>	<i>41</i>
3.5.2	<i>Data transmission .....</i>	<i>41</i>
3.5.3	<i>Software update .....</i>	<i>42</i>
<b>4</b>	<b>TROUBLESHOOTING.....</b>	<b>43</b>
<b>5</b>	<b>METER POWER SUPPLY .....</b>	<b>45</b>

5.1	MONITORING OF THE POWER SUPPLY VOLTAGE.....	45
5.2	REPLACEMENT OF BATTERIES .....	45
5.3	GENERAL PRINCIPLES REGARDING USING NI-MH ACCUMULATORS.....	48
<b>6</b>	<b>CLEANING AND MAINTENANCE.....</b>	<b>49</b>
<b>7</b>	<b>STORAGE .....</b>	<b>49</b>
<b>8</b>	<b>DISMANTLING AND UTILISATION .....</b>	<b>49</b>
<b>9</b>	<b>TECHNICAL SPECIFICATIONS .....</b>	<b>50</b>
9.1	BASIC DATA .....	50
9.2	ADDITIONAL DATA .....	55
9.2.1	<i>Additional uncertainties according to IEC 61557-2 (R<sub>ISO</sub>).....</i>	<i>55</i>
9.2.2	<i>Additional uncertainties according to IEC 61557-3 (Z).....</i>	<i>55</i>
9.2.3	<i>Additional uncertainties according to IEC 61557-4 (R ±200mA) .....</i>	<i>56</i>
9.2.4	<i>Resistance of voltage electrode R<sub>s</sub>[Ω] Additional uncertainties according to IEC 61557-6 (RCD).....</i>	<i>56</i>
<b>10</b>	<b>EQUIPMENT .....</b>	<b>56</b>
10.1	STANDARD EQUIPMENT.....	56
10.2	OPTIONAL ACCESSORIES .....	56
<b>11</b>	<b>MANUFACTURER .....</b>	<b>57</b>



# 1 Safety

MPI-505 meter is designed for performing check tests of protection against electric shock in mains systems. The meter is used for making the measurements the results of which determine safety of electrical installations. Therefore, in order to provide conditions for correct operation and the correctness of the obtained results, the following recommendations must be observed:

- Before you proceed to operate the meter, acquaint yourself thoroughly with the present manual and observe the safety regulations and specifications determined by the producer.
- Any application that differs from those specified in the present manual may result in a damage to the device and constitute a source of danger for the user.
- The device must be operated solely by appropriately qualified personnel with relevant certificates to realise measurements of electric installation. Operation of the meter realised by unauthorised personnel may result in damage to the device and constitute a source of danger for the user.
- Using this manual does not exclude the need to comply with occupational health and safety regulations and with other relevant fire regulations required during the performance of a particular type of work. Before starting the work with the device in special environments, e.g. potentially fire-risk/explosive environment, it is necessary to consult it with the person responsible for health and safety.
- It is unacceptable to operate the following:
  - ⇒ A damaged meter which is completely or partially out of order,
  - ⇒ A meter with damaged test leads insulation,
  - ⇒ A meter stored for an excessive period of time in disadvantageous conditions (e.g. excessive humidity). If the meter has been transferred from a cool to a warm environment of a high level of relative humidity, do not realise measurements until the meter has been warmed up to the ambient temperature (approximately 30 minutes).
- It should be remembered that **BAT** message appearing on the display indicates that supply voltage of the meter is too low. This message signals also that the batteries must be replaced or the accumulator charged. Measurements performed by means of the meter whose supply voltage is too low are burdened with additional errors that are impossible to be estimated by the user. Such measurements must not be relied on in order to state correctness of protection of a network tested.
- Battery spill and damage to the meter may occur if discharged batteries are left in the meter.
- Before measurements may commence, make sure the test leads are connected to the appropriate measurement sockets.
- Do not operate a meter with an open or incorrectly closed battery (accumulator) compartment or power it from other sources than those specified in the present manual.
- The  $R_{ISO}$  inputs of the meter are protected electronically from overload (e.g. due to having been connected to a live circuit) up to 440V rms for 60 seconds.
- Repairs may be realised solely by an authorised service point.

## **ATTENTION!**

**Only standard and additional accessories for a given device should be used, as listed in the "Equipment" section. Use of different accessories can lead to errors in the test connection and can introduce additional measurement uncertainties.**

## **Attention:**

**Due to continuous development of the meter's software, the actual appearance of the display, in case of some of the functions, may slightly differ from the display presented in this operating manual.**

**Note:**

An attempt to install drivers in 64-bit Windows 8 may result in displaying "Installation failed" message.

**Cause:** Windows 8 by default blocks drivers without a digital signature.

**Solution:** Disable the driver signature enforcement in Windows.

## 2 Measurements

**WARNING:**

During measurements (short circuit loop, RCD), do not touch earthed and accessible parts of the tested electrical installation.

**WARNING:**

During a measurement, switching of the range switch is forbidden because it may damage the meter and pose a threat to the user.

### 2.1 Selection of general measurement parameters

①

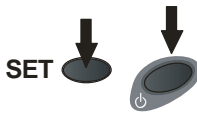

Keeping **SET** button depressed, turn on the meter and wait for the parameter selection screen.



**SEL** button is used to go to the next parameter and to confirm the changes in the currently displayed parameter.

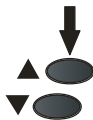

Use ▲ and ▼ buttons to change the parameter value. The value or symbol to be changed is flashing.

The **YES** symbol indicates an active parameter, the **no** - symbol indicates an inactive one.

②

Set the parameters according to the following algorithm:

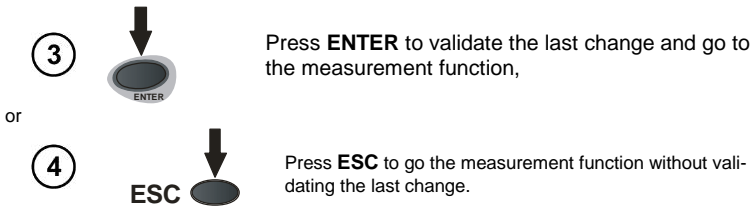
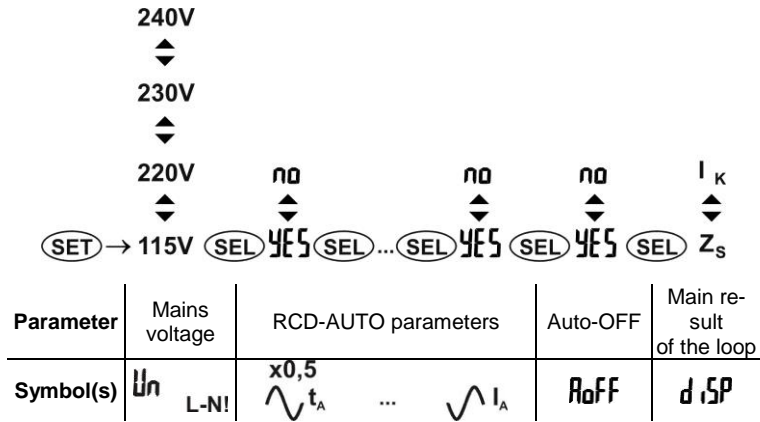

## Note:

- Before first measurements, select the mains rated voltage  $U_n$  (115/200V, 220/380V, 230/400V or 240/415V), used in the area where measurements are performed. This voltage value is used for calculating the values of prospective short-circuit current.
- Symbol  $\sim$  in this case indicates positive phase/polarity, while symbol  $\sphericalangle$  - negative.

## 2.2 Remembering the last measurement result

The result of the latest measurement is remembered by the meter until a next measurement is started or measurement settings are changed or the measuring function is changed by means of the rotary switch or the meter is switched off. When you go to the output screen of a given function, you can recall this result with **ESC** button by pressing **ENTER**. This applies to Z, RCD and  $R_{ISO}$  measurements. The result of last measurement is remembered even after the meter is turned off and on again.

## 2.3 Measurement of alternating voltage (AC)

The meter measures and displays alternating mains voltage in all measuring functions except **R**. This voltage is measured for the frequencies within the range of 45..65 Hz. The test leads should be connected as for a given measuring function.

## 2.4 Checking the correctness of PE (protective earth) connections

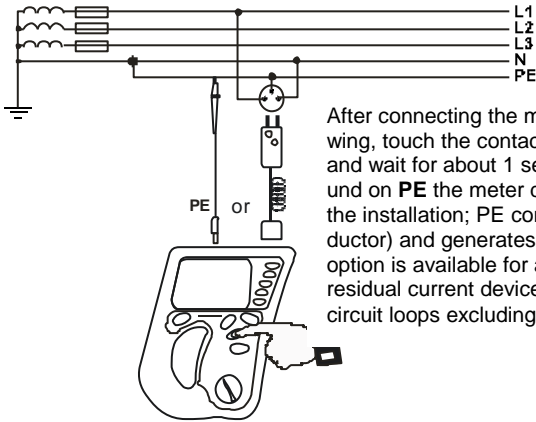

After connecting the meter according to the drawing, touch the contact electrode with a finger and wait for about 1 second. When voltage is found on **PE** the meter displays symbol **PE** (error in the installation; PE connected to the phase conductor) and generates a continuous beep. This option is available for all measuring functions of residual current devices (RCD) and for short circuit loops excluding **Z<sub>L-N,L-L</sub>**.

### Note:

#### WARNING:

When a dangerous voltage is detected on PE conductor, measurements must be immediately stopped and a fault in the installation must be removed.

- The person making a measurement must ensure that he/she is standing on a non-insulated floor during the measurement; otherwise the result of the measurement may be incorrect.
- The threshold value, which triggers the signal of exceeded allowable voltage on PE conduit, is approximately 50 V.

## 2.5 Measurement of fault loop parameters



If there are residual current devices in the network tested, they should be bypassed by bridging for the period of impedance measurement. However, it should be remembered that the tested circuit is modified in this way and the obtained results may slightly differ from the actual results.

After completing measurements, always remove modifications introduced to the tested system for the period of measurements and check the operation of the residual current switch.

The above remark does not apply to measurements of short circuit loop impedance with **Z<sub>L-PE</sub>** **RCD** function.



Measurements of fault loop impedance performed downstream of inverters are ineffective and their results are unreliable. This is due to the instability of internal impedance in inverter circuits during its operation. The measurements of fault loop impedance should not be performed directly downstream of inverters.

## 2.5.1 Selection of measurement parameters

①

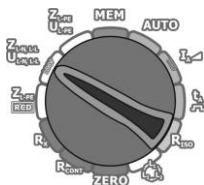

Turn the rotary switch to one of the loop impedance measurement ranges.

②

Set the parameters according to the following algorithm, and according to the rules described in general parameters setting.

**NOTE:** WS-01 test lead with a mains plug is detected by the meter and after that it is impossible to select the length of the test lead (symbol  $\text{---}E$  is displayed). Before starting to measurement, using test leads terminated with banana plugs, select the appropriate length of the phase conductor, compatible with the length of the test lead used for measurement.

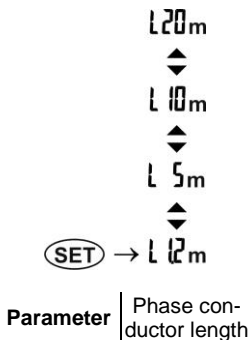

### Note:



Using test leads from known manufacturers and selecting the correct length guarantees the declared measurement accuracy.

## 2.5.2 Prospective short-circuit current

The meter always measures impedance. The short-circuit current is calculated according to the following formula:

$$I_k = \frac{U_n}{Z_s}$$

where:  $U_n$  - mains rated voltage,  $Z_s$  - measured impedance.

On the basis of  $U_n$  rated voltage selected (section 2.1), the meter automatically recognizes the measurement at phase-to-neutral or phase-to-phase voltage and takes it into account in the calculations.

If the voltage of the network being tested is outside the tolerance range, the meter will not be able to determine a proper rated voltage for the short-circuit current calculation. In such a case, horizontal dashes will be displayed instead a short-circuit current value. The following diagram shows voltage ranges for which short-circuit current value is calculated.

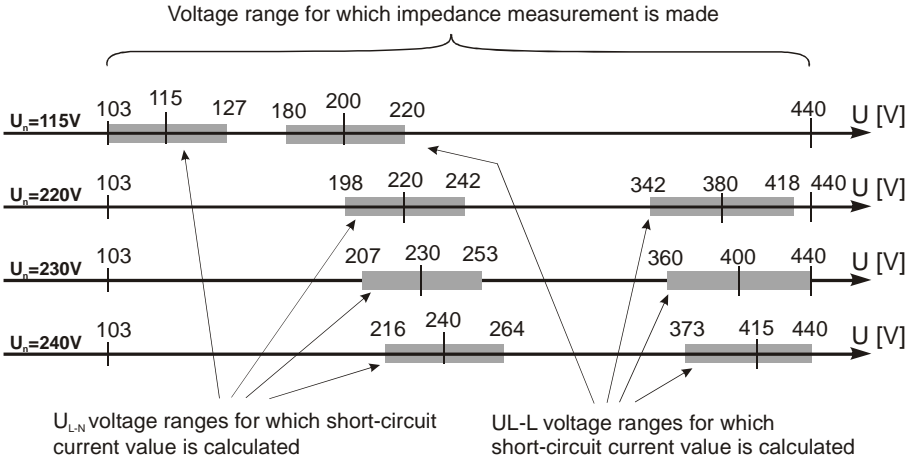

### 2.5.3 Measurement of fault loop parameters in the L-N and L-L circuits

①

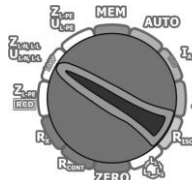

Turn on the meter.  
Turn the rotary switch to  $Z/U_{L-N,L-L}$  position.

②

Depending on the needs, select the measurement parameters according to section 2.5.1.

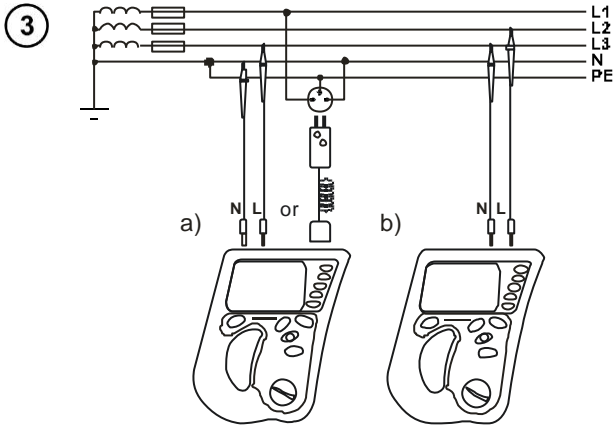

Connect test leads according to the drawing  
a) for measurement in the L-N circuit or  
b) for measurement in the L-L circuit

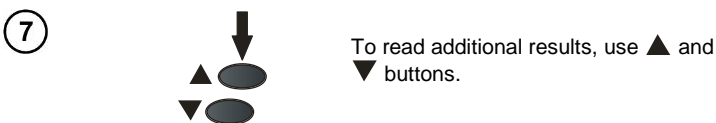
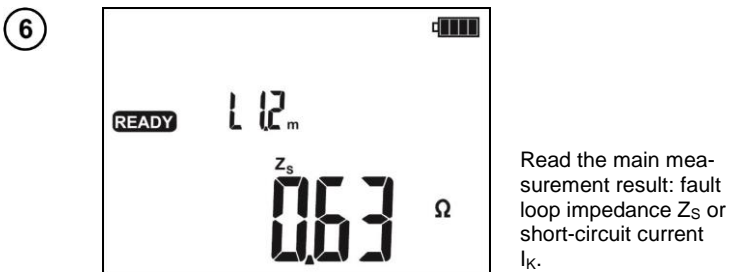
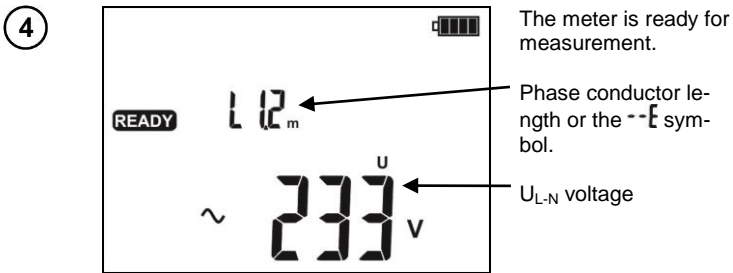

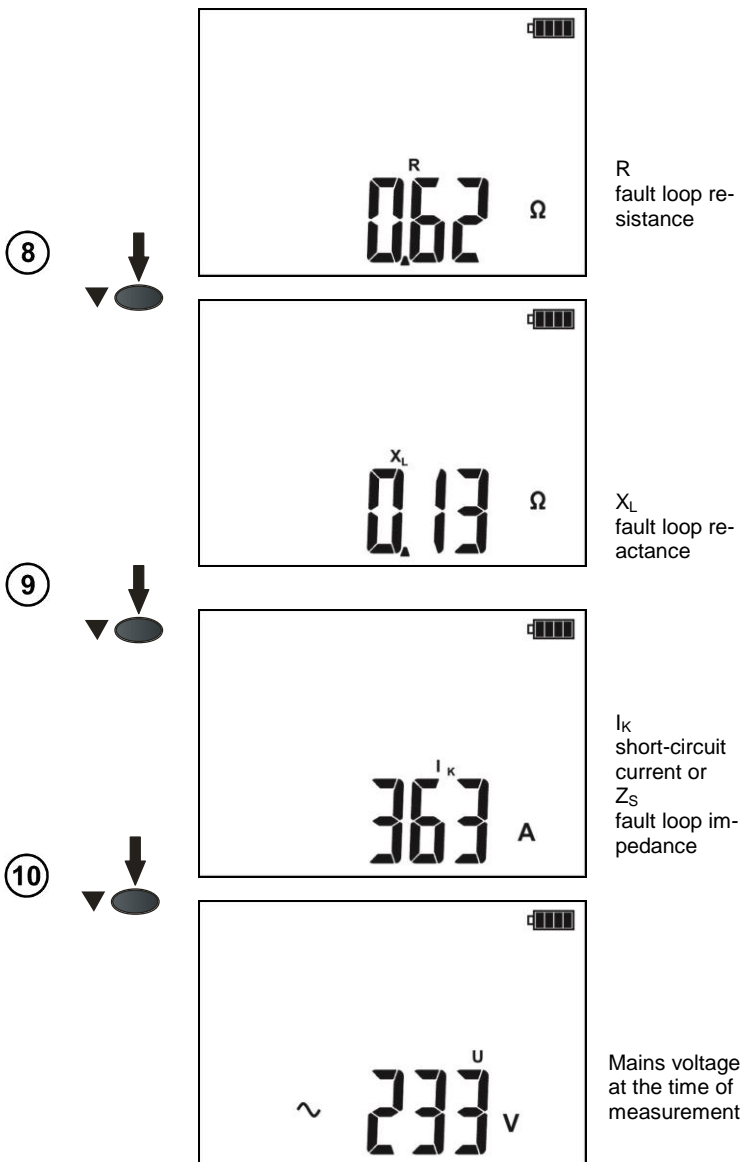

## Note:

- Enter the result into memory (see section 3.2) or press **ESC** to return to the voltage measurement.
- When many measurements are made in short time intervals, the meter may emit a large amount of heat. As a result of this, the enclosure of the device may become hot. This is normal and the meter is equipped with the protection against excessive temperature.
- Minimum interval between successive measurements is 5 seconds. This is controlled by the meter which displays the message **READY** informing that the measurement can be made.



## Additional information displayed by the meter

<b>READY</b>	The meter is ready for measurement.
<b>L-N!</b>	Voltage on terminals <b>L</b> and <b>N</b> is not within the measurable range.
<b>Err</b>	Error during the measurement.
<b>ErrU</b>	Error during the measurement – voltage dip after the measurement.
<b>EOO</b>	Short circuit malfunction!

### 2.5.4 Measurement of fault loop parameters in the L-PE circuit

1

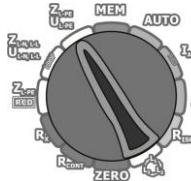

Turn on the meter.  
Turn the rotary switch to **Z/UL-PE** position.

2

Depending on the needs, select the measurement parameters according to section 2.5.1.

3

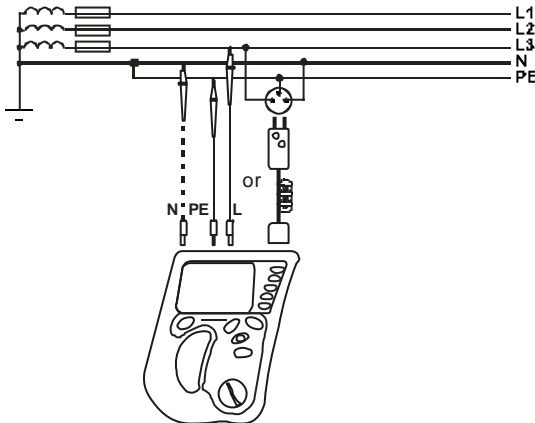

Connect the test leads according to one of the drawings.

Checking effectiveness of protection against electric shock of the enclosure in case of: a) TN b) TT.

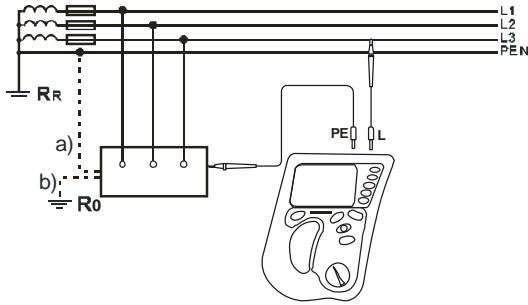

4

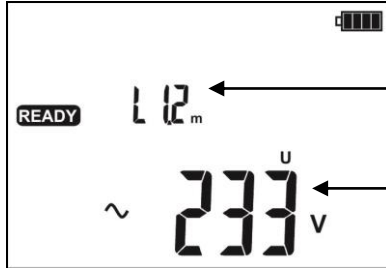

The meter is ready for measurement.

Phase conductor length or the  $\sim$  symbol.

$U_{L-PE}$  voltage.

5



Make measurement by pressing **START** push-button.

Remaining issues connected with the measurements are the same as those described for measurements in L-N circuit or L-L circuit.

## Note:

- Double lead measurement is possible when a test lead other than the lead with a mains socket is selected.

## Additional information displayed by the meter

<b>READY</b>	The meter is ready for measurement.
<b>L-N!</b>	For the lead with the plug - voltage on terminals <b>L</b> and <b>N</b> is not within the measurable range.
<b>L-PE!</b>	Voltage on terminals <b>L</b> and <b>PE</b> is not within the measurable range.

Error messages - as for the L-N and L-L measurement.

### 2.5.5 Measurement of short circuit loop impedance in L-PE circuit protected with a residual current device (RCD)

MPI-505 enables the user to measure fault loop impedance without altering the systems equipped with RCD's and with the rated current of at least 30mA.

1

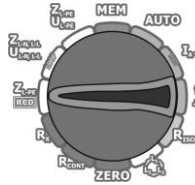

Turn on the meter.  
Turn the rotary switch to  $Z_{L-PE}^{RCD}$  position.

2

Depending on the needs, select the measurement parameters according to section 2.5.1.

3

Connect the test leads according to one of the drawings.

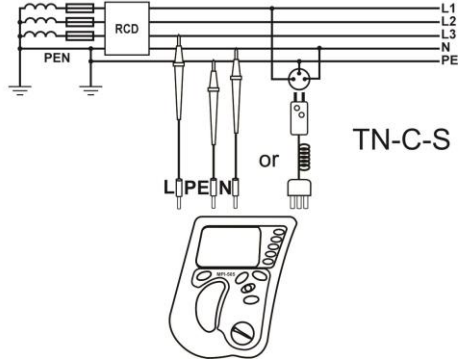
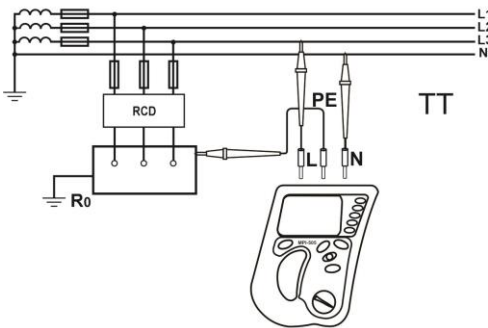
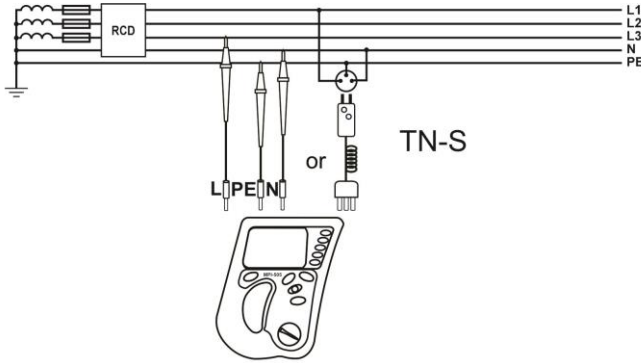

Remaining issues connected with the measurements are the same as those described for measurements of the L-PE circuit.

**Note:**

- Maximum measurement time is about 32 seconds. The measurement can be interrupted by pressing the **ESC** button.
- In the electrical installations with 30 mA RCD's the sum of leakage currents of the installation and the test current may trigger the RCD. If this happens, try to reduce the leakage current in the tested mains (for example by disconnecting loads).

## Additional information displayed by the meter

<b>READY</b>	The meter is ready for measurement.
<b>L-N!</b>	Voltage on terminals <b>L</b> and <b>N</b> is not within the measurable range.
<b>L-PE!</b>	Voltage on terminals <b>L</b> and <b>PE</b> is not within the measurable range.
<b>⏏ n</b>	Conductor <b>N</b> is not connected.
<b>NOISE!</b>	Huge noise in the system during the measurement. The measurement result may be affected by a large, unspecified uncertainty.

Error messages - as for the L-N and L-L measurement.

## 2.6 Measurement of RCD parameters



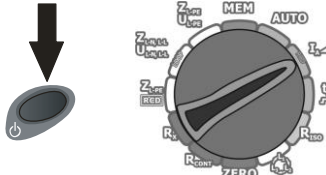

### 2.6.1 Measurement of RCD disconnection current

**1**



Turn on the meter.  
Turn the rotary switch to **I<sub>Δn</sub>** position.

**2** Set the parameters according to the following algorithm, and according to the rules described in general parameters setting.

1000mA	↕							
500mA	↕							
300mA	↕							
100mA	↕							
30mA	↕		(selective)	<b>S</b>	50V	$I_{A1}, t_{A1}, U_{B1}, R_E$		
	↕		(ordinary)	<b>□</b>	25V	$U_{B1}, R_E$		
<b>(SET)</b> → 10mA		<b>(SEL)</b> 			(for selective RCD's)			
				<b>(SEL)</b> <b>□</b>	12.5V	$I_{A1}, U_{B1}, R_E$		

Parameter	I <sub>Δn</sub>	Current waveform	Type of RCD	U <sub>L</sub>	Measurement mode

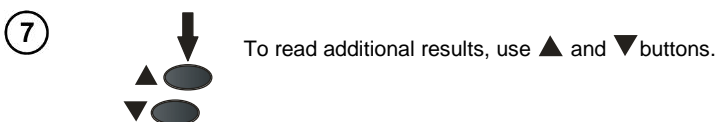
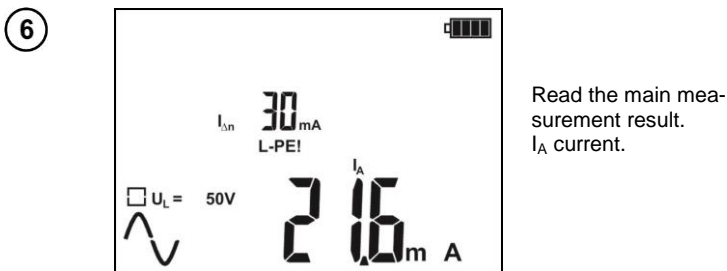
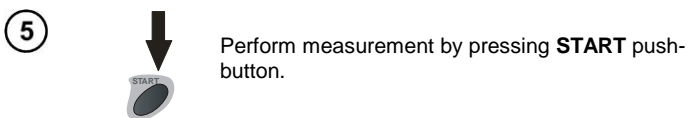
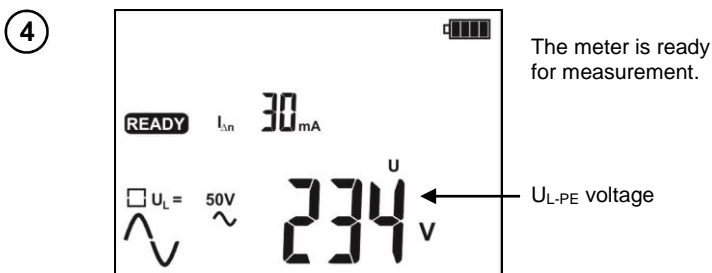
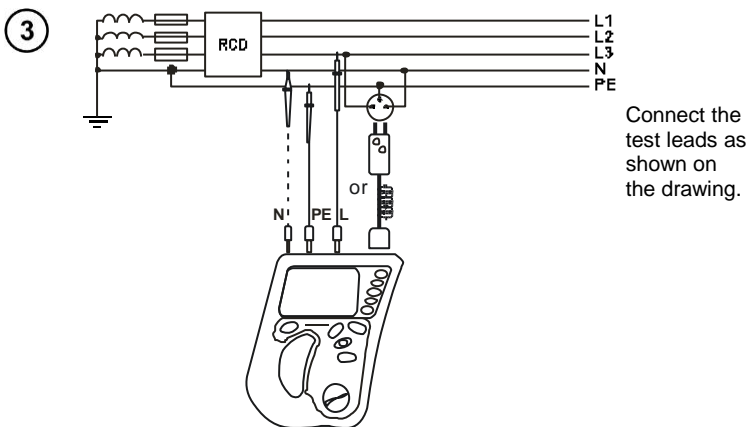

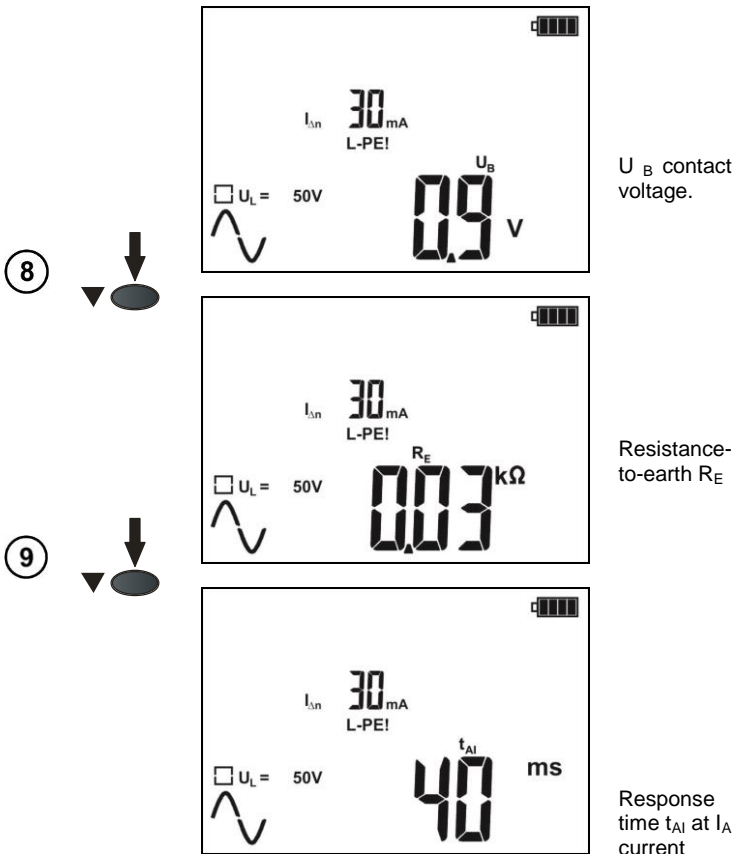



## Note:

- Measurement of  $t_{AI}$  disconnection time for selective RCD is not available.
- If you select only  $U_B$ ,  $R_E$  measurements then these values are measured with  $0.4I_{\Delta n}$  current without tripping RCD's. If during this measurement, RCD is tripped, further measurements may be carried out after pressing **ESC**.
- Due to the nature of the measurement (increase of  $I_A$  current in steps), measured disconnection/response time  $t_{AI}$  in this mode may include a positive error or as a result of RCD inertia, the following symbol may be displayed: **r.c.d.** If the result is not within the acceptable range for a given RCD, repeat the measurement in  $t_A$  mode (section 2.6.2).
- Enter the result into memory (see section 3.2) or press, **ESC**, to return to displaying only voltage value. The last measurement result is stored until **START** button is pressed again or the position of rotary switch is changed. It is remembered even after the meter is turned off and on again.

## Additional information displayed by the meter

<b>READY</b>	The meter is ready for measurement.
<b>L-PE!</b>	Voltage on terminals <b>L</b> and <b>PE</b> is not within the measurable range.
	L and N conductors have been switched (voltage between terminals <b>PE</b> and <b>N</b> ).
	The temperature inside the meter has risen above the limit, the measurement is blocked.
<b>rCD</b>	RCD is inactive.
<b>U<sub>b</sub></b>	Safe contact voltage exceeded.

### 2.6.2 Measurement of RCD disconnection time

1

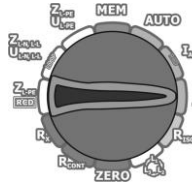

Turn on the meter.  
Turn the rotary switch to **t<sub>A</sub>** position.

2

Set the parameters according to the following algorithm, and according to the rules described in general parameters setting.

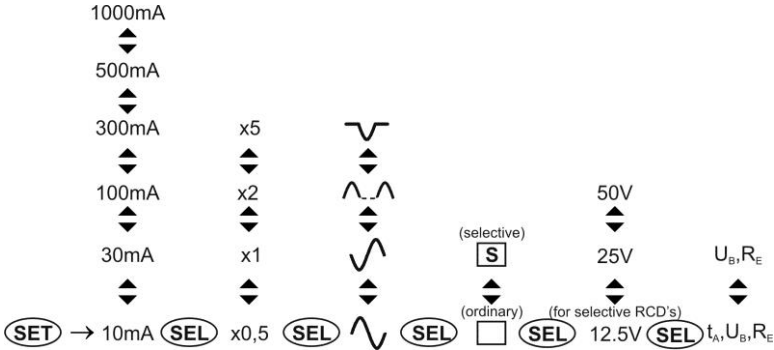

Parameter	I <sub>Δn</sub>	Multiplication factor I <sub>Δn</sub>	Current waveform	Type of RCD	U <sub>L</sub>	Measurement mode
-----------	-----------------	---------------------------------------	------------------	-------------	----------------	------------------

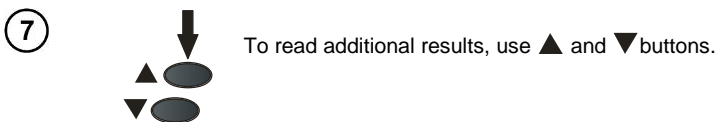
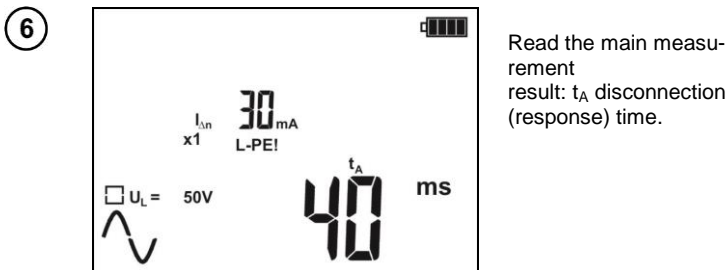
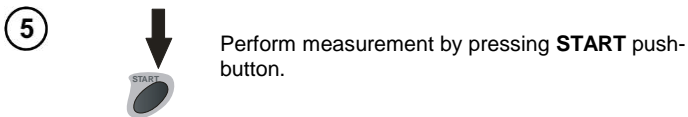
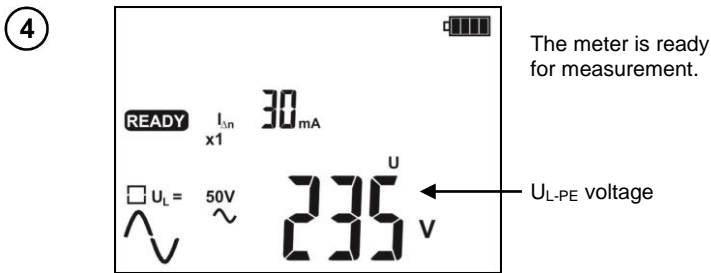
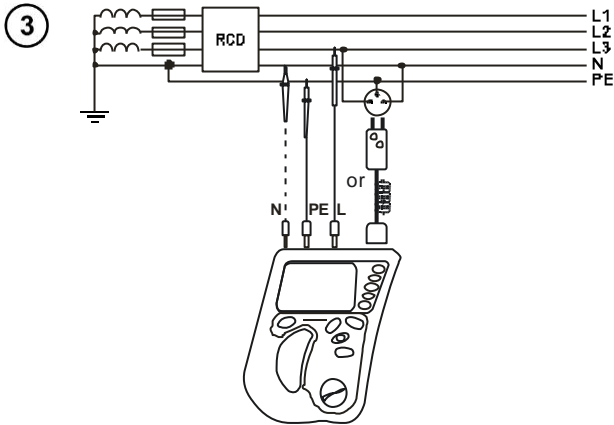



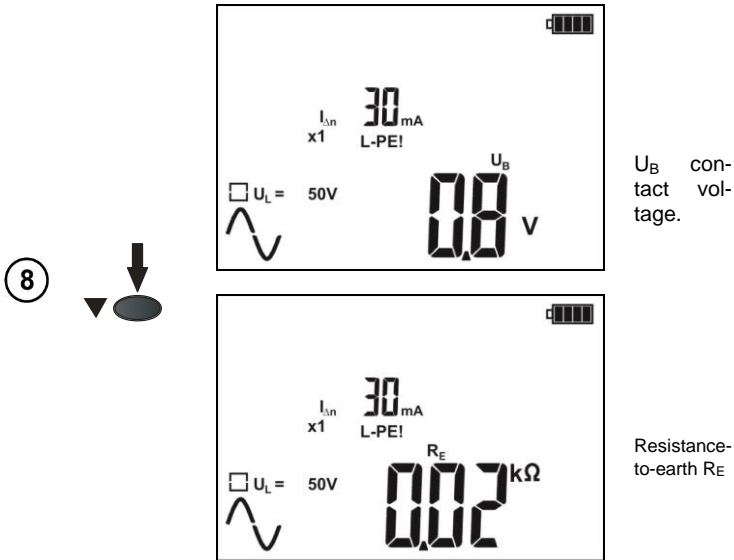

Messages and information displayed by the meter as in Section 2.6.1.

### 2.6.3 Automatic measurement of RCD parameters

The meter enables user to measure automatically RCD triggering time ( $t_A$ ), disconnection current ( $I_A$ ), contact voltage ( $U_B$ ) and resistance-to-earth ( $R_E$ ). In this mode, there is no need to trigger the measurement for every single measurement and the role of the user is reduced to initiate the measurement and switch on RCD after each tripping. The below table shows maximum number of parameters measured and sequence of measurements for pre-set value of rated current  $I_{\Delta n}$ , selected current waveform, type of RCD (standard / selective) and  $U_L$  voltage.

No.	Parameters measured	Measurement conditions	
		$I_{\Delta n}$ multiplication factor	Initial phase (polarization)
1.	$U_B, R_E$		
2.	$t_A$	$0.5I_{\Delta n}$	positive
3.	$t_A$	$0.5I_{\Delta n}$	negative
4.*	$t_A$	$1I_{\Delta n}$	positive
5.*	$t_A$	$1I_{\Delta n}$	negative
6.*	$t_A$	$2I_{\Delta n}$	positive
7.*	$t_A$	$2I_{\Delta n}$	negative
8.*	$t_A$	$5I_{\Delta n}$	positive
9.*	$t_A$	$5I_{\Delta n}$	negative
10.*	$I_A$		positive
11.*	$I_A$		negative

\* points in which an efficient RCD should be triggered

Parameters to be measured according to the above table are set as described in Section 2.1.

1

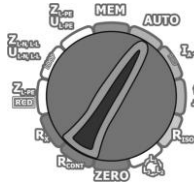

Turn on the meter.  
Turn the rotary switch to **AUTO** position.

2

If displayed parameters differ from those required, set them according to the following algorithm, and according to the rules described in general parameters setting.

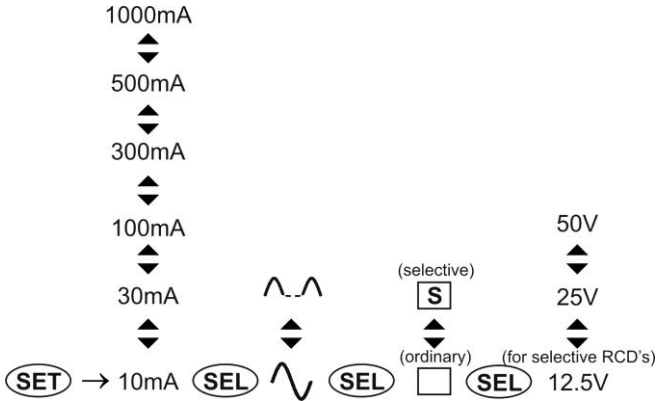

Parameter	$I_{Ln}$	Current waveform	Type of RCD	$U_L$
-----------	----------	------------------	-------------	-------

3

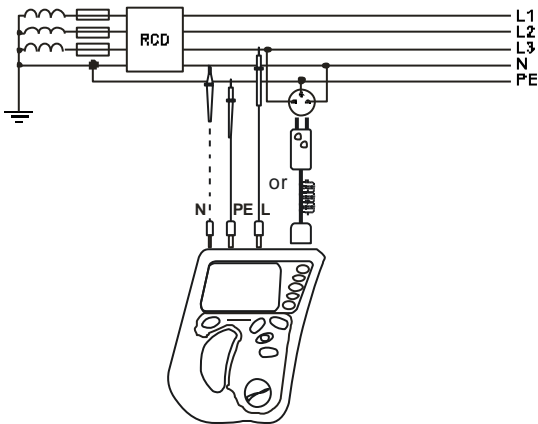

Connect test leads according to the drawing.

4

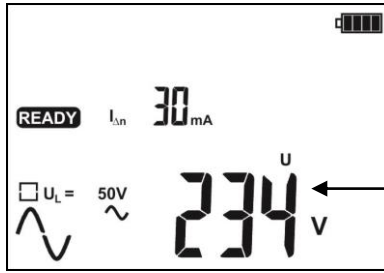

The meter is ready for measurement.

$U_{L-PE}$  voltage

5



Press **START** button to start measurement.

6

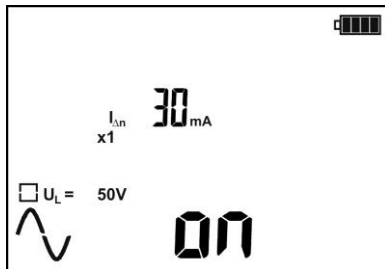

After each activation turn-on tested RCD.

7

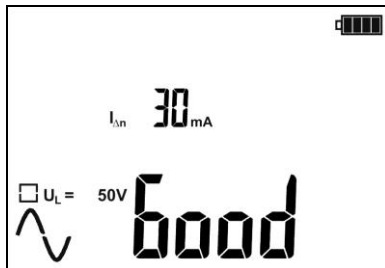

Read the main measurement result: **Good** - good or **bad** - bad.

8

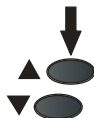

Perform further measurements repeating steps from ⑤ or read additional results using ▲ and ▼ buttons.

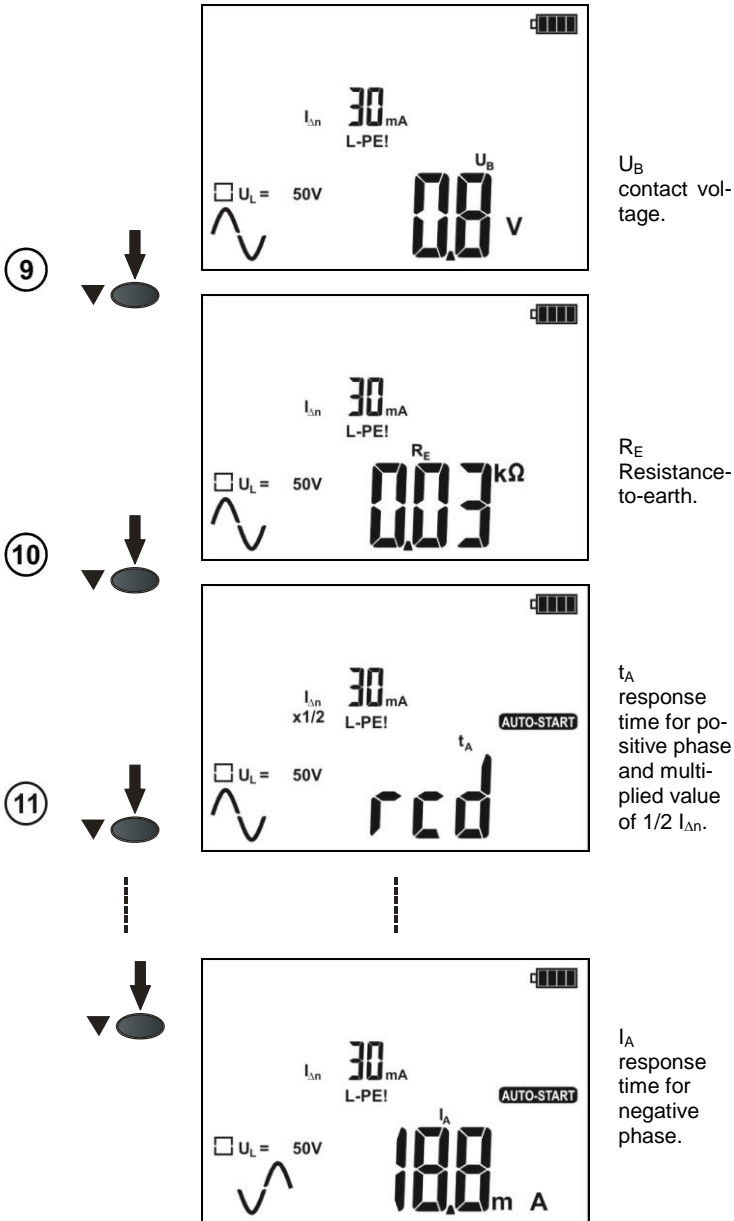

**Note:**

- The measurement is interrupted, if during measurement of  $U_B/R_E$ , RCD has been triggered at  $0.5I_{\Delta n}$  current or if RCD has not been triggered in other cases or if a preset value of safe voltage  $U_L$  has been exceeded.

- Enter the result into memory (see section 3.2) or press **ESC** to return to displaying only voltage value.

## Additional information displayed by the meter

<b>bood</b>	RCD in good working order.
<b>bRd</b>	RCD not in god working order.
<b>on</b>	Switch on the RCD.
<b>AUTO-START</b>	the parameter was measured in <b>AUTO</b> mode.

Other information displayed by the meter as in Section 2.6.1.

## 2.7 Measurement of insulation resistance

**WARNING:**  
The object tested must not be live.

### 2.7.1 Measurement of insulation resistance of individual objects

①

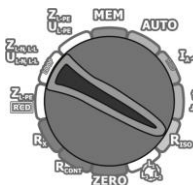

Turn on the meter.  
Turn the rotary switch  
to **Riso** position.

②

Set the measurement voltage according to the following algorithm, and according to the rules described in general parameters setting.

1kV



500V



250V



**SET** → 100V

Parameter |  $U_N$

3

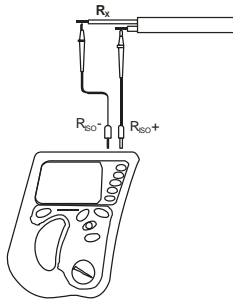

Connect test leads according to the drawing.

4

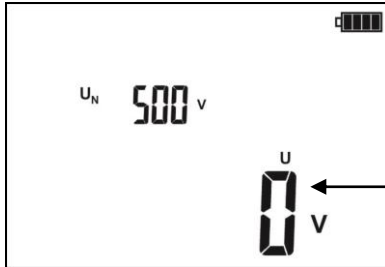

The meter is ready for measurement.

Voltage present on tested object.

5

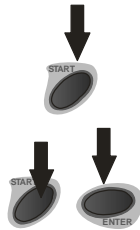

Press and hold **START** push-button. The measurement is performed continuously as long as the push-button is held in the pressed position.

In order to maintain (block) the measurement press **ENTER** button while holding **START** button pressed. In order to interrupt the measurement, press **ESC** or **START**.

6



Read out the result.

### Note:



During measurements of insulation resistance, dangerous voltage up to 1 kV occurs at the ends of test leads of MPI-505.



**It is forbidden to disconnect test leads and to change the position of the function switch before completion of measurement. Failure to obey the above instruction will lead to high voltage electric shock and make it impossible to discharge the tested object.**

- The meter emits a continuous audio signal until test voltage reaches 90% of the preset value (and also when 110% of the preset value is exceeded).
- During measurement, the meter generates a beep every five seconds - it facilitates capturing time parameters.
- When the measurement cycle is upheld by pressing **ENTER** it is indicated by:
  - a short break in the beep, when the test voltage has not reached 90% or exceeded 110% of set value
  - a short beep if the test voltage is between 90% and 110% of set value
- Bargraph shows the approximate value of the resistance.
- After completion of measurement, the capacitance of the tested object is discharged by shorting **Riso+** and **Riso-** terminals with resistance of 100 k $\Omega$ .
- Enter the result into memory (see section 3.2) or press **ESC** to return to the voltage measurement.

## Additional information displayed by the meter

	The tested object is live. The measurement is blocked. <b>Immediately disconnect the meter from the tested object (both leads)!</b>
	Activation of current limit. The symbol displayed is accompanied by a continuous beep.
	The tested object is live. The measurement is possible, but without guaranteed accuracy.
	The insulation resistance is too low, the measurement is terminated. This symbol appears when during the measurement the insulation breakdowns.
$> 500^{M\Omega}, > 1000^{M\Omega},$ $> 1999^{M\Omega}, > 300^{G\Omega}$	Measuring range is exceeded.
	The tested object is being discharged.

### 2.7.2 Additional Information

The meter measures the insulation resistance by applying to tested resistance  $R_x$  tested voltage  $U$  and measuring current  $I$  flowing through it, which is controlled from **Riso+** terminal side. In calculating the value of insulation resistance, the meter applies the technical method of resistance measurement ( $R_x=U/I$ ). The test voltage is chosen from four values: 100V, 250V, 500V or 1000V.

Inverter output current is limited at 1 mA level. The measurement result is correct, but on the test terminals the test voltage is lower than voltage selected before the measurement (as illustrated in figure below). Quite often current limitation may occur in the first phase of the measurement due to charging the capacity of the tested object.

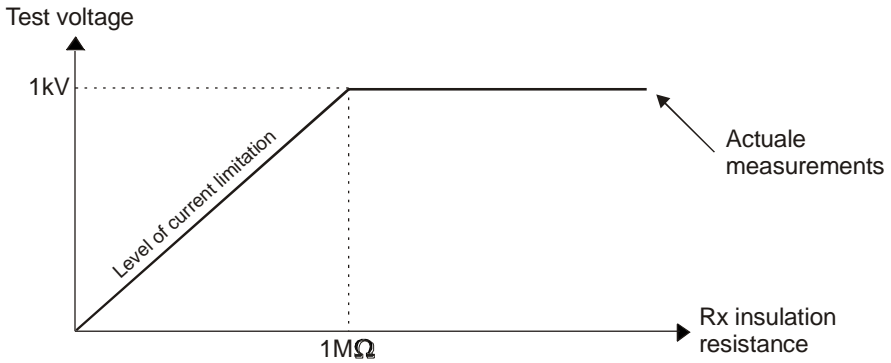

## 2.8 Low-voltage measurement of resistance



The meter may be damaged if connected to the voltage exceeding 440V<sub>DC</sub>.

### 2.8.1 Measurement of continuity of protective conductors and equipotential bondings with ±200 mA current

①

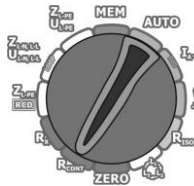

Turn on the meter.  
Turn the rotary switch to **R<sub>CONT</sub>** position.

②

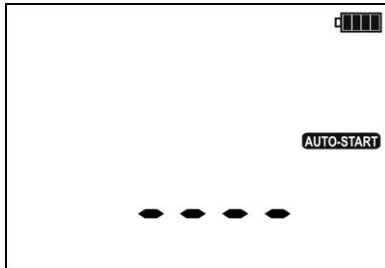

The meter is ready for measurement.



3

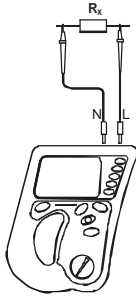

Connect the test leads according to the drawing, the measurement starts automatically.

4



With connected test leads another measurement may be started by pressing **START**.

5

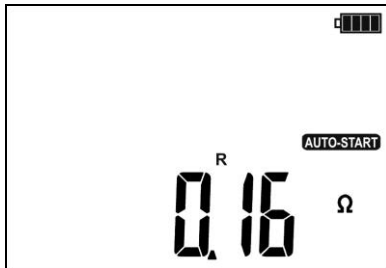

Read the main measurement result which is the arithmetic mean of two measurements with 200mA current flowing in opposite directions.

6

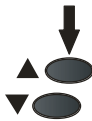

To read additional results, use ▲ and ▼ buttons.

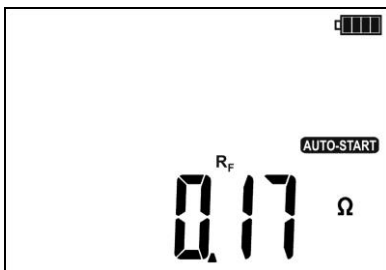

$R_F$   
resistance at  
current flow  
of +200mA

7

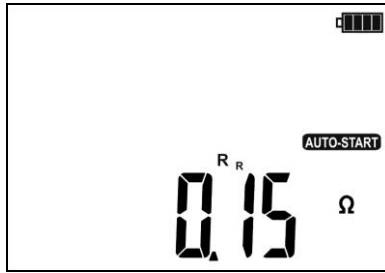

$R_R$   
resistance at  
current flow of  
-200mA

## Additional information displayed by the meter

<b>UdEt</b>	The tested object is live. The measurement is blocked. <b>Immediately disconnect the meter from the tested object (both leads)!</b>
<b>NOISE!</b>	The tested object is live and under voltage ranging from 0.1 to 3Vpp (AC+DC). The measurement is possible, but without guaranteed accuracy.
> <b>400</b> °	Measuring range is exceeded.

### 2.8.2 Low-current measurement of resistance

1

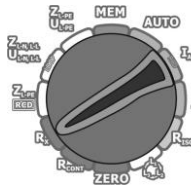

Turn on the meter.  
Turn the rotary switch  
to position **Rx**.

2

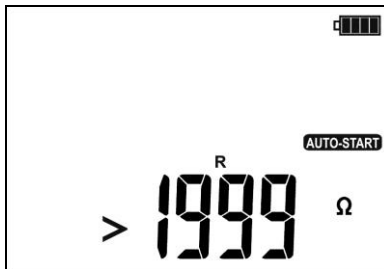

The meter is ready  
for measurement.

3

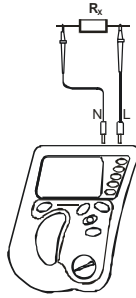

Connect the test leads as shown on the drawing.

4

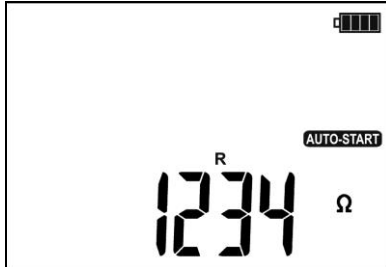

Read the measurement result.

### Additional information displayed by the meter

UdEt	The tested object is live. The measurement is blocked. <b>Immediately disconnect the meter from the tested object (both leads)!</b>
NOISE!	The tested object is live and under voltage ranging from 0.05 to 3Vpp (AC+DC). The measurement is possible, but without guaranteed accuracy.
> 1999 <sup>a</sup>	Measuring range is exceeded.

### 2.8.3 Compensation of test leads resistance - autozeroing

1

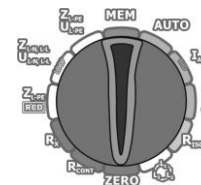

Turn on the meter. Turn the rotary switch to **ZERO** position.

2

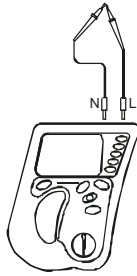

Short the test leads.

3



Perform compensation by pressing **START** button.

4

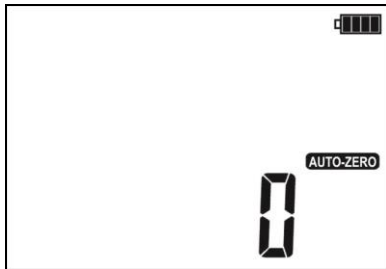

After completing the auto-zero, the following screen will be displayed.

## Note:

- The **AUTO-ZERO** message remains on the display after switching into one of the measurement functions (resistance or continuity measurement) indicating that the measurement is made with compensated least leads resistance.
- To remove the compensation, perform the above-mentioned activities but with open test leads. Then the **OFF** symbol will be displayed.

## Additional information displayed by the meter

	The tested object is live. The measurement is blocked. <b>Immediately disconnect the meter from the tested object (both leads)!</b>
--	---

## 2.9 Checking sequence of phases

1

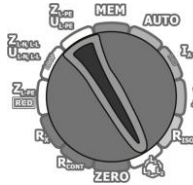

Turn on the meter.  
Turn the rotary switch  
to position .

2

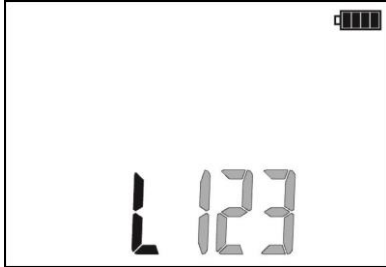

Blinking digits indicate  
no or low voltage of  
the phases.

3

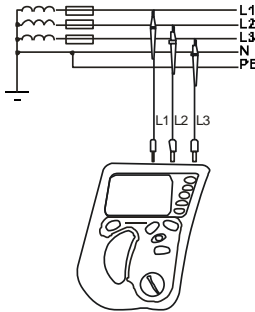

Connect test leads  
according to the drawing.

4



A set of lines moving  
along the bargraph in-  
dicates the phase  
sequence:  
moving to the right -  
consistent,  
moving to the left -  
opposite.

5

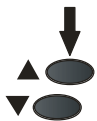

Individual phase-to-phase voltages may be read  
using ▲ and ▼ buttons.



After a few seconds or after pressing **ESC** button, the meter returns to displaying the phase sequence.

### 3 Memory of measurement results

MPI-505 meters are equipped with the memory that can store 3500 single measurement results. The whole memory is divided into 10 memory banks with 99 cells in each bank. Thanks to dynamic memory allocation, each of the memory cells can contain different quantity of single measurement results, depending on the needs. Optimal use of the memory can be ensured in this way. Each measurement result can be stored in a memory cell marked with a selected number and in a selected memory bank. Thanks to this, the user of the meter can, at his/her option, assign memory cell numbers to individual measurement points and the memory bank numbers to individual facilities. The user can also perform measurements in any sequence and repeat them without losing other data.

Memory of measurement results **is not deleted** when the meter is switched off. Thanks to this, the data can be later read or sent to a computer. The number of a current memory cell or memory bank is not changed either.

#### Note:

- Results of measurements performed for all measuring functions can be stored in one memory cell.
- After each entry of the measurement result to the cell, its number is automatically incremented. Set the appropriate cell number to allow entering to a single cell of successive measurement results relating to a given measuring point (facility).
- Only the results of the measurements started by pressing **START** button can be stored in the memory (except autozeroing in low-voltage measurement of resistance).
- It is recommended to delete the memory after reading the data or before performing a new series of measurements that may be stored into the same memory cells as the previous ones.

#### 3.1 Storing the measurement result data in the memory

①

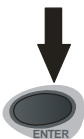

Press **ENTER** after completion of the measurement.  
The meter is in the memory storing mode.

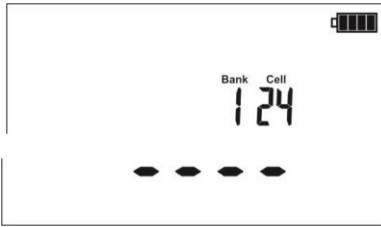

Cell is empty.

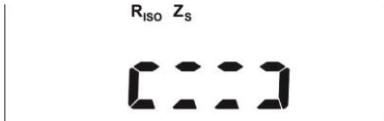

The cell contains the measurement results of the displayed types.

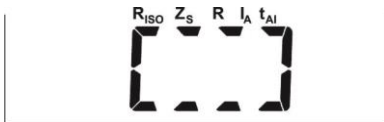

The cell contains the measurement results of the displayed types.

2



Press **SEL** to view the result types...

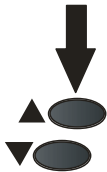

...or use ▲ and ▼ to see individual components of the results (if the bank or cell number does not flash - see section 3.2).



3

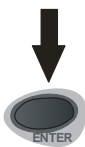

Select the bank and cell number (see section 3.2) or leave the current number. Then press **ENTER** again. The following screen appears for a moment, accompanied by three short beeps, and then the meter returns to display the last result of the measurement.

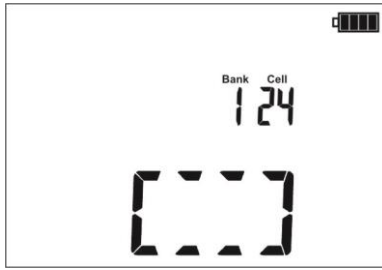

④

An attempt to overwrite a result causes the warning symbol to appear.



⑤

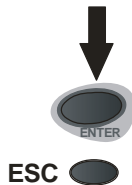

Press **ENTER** to overwrite the result or **ESC** to abort.

## Note:

- In case of RCD's the above warning message will appear also when an attempt is made to store a result of specific measurement (or result component) that has been made at different pre-set of  $I_{\Delta n}$  current or for a different type of RCD set (standard / selective) than the measurements the results of which are already stored in this cell, despite the fact that the memory space designated for this result component may be free. When results of measurements made for a different type of RCD or a different  $I_{\Delta n}$  current are stored, the results concerning a given RCD that have been stored previously will be lost.

- Complete set of results (main result and supplementary results) for a given measuring function and preset measurement settings are stored in the memory.

## 3.2 Changing the cell and bank number

①

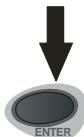

Press **ENTER** after completion of the measurement.  
The meter is in the memory storing mode.





2

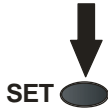

Press **SET**.



The cell number is flashing.  
To change use ▲ and ▼ buttons.

3

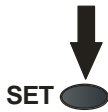

Press **SET**.

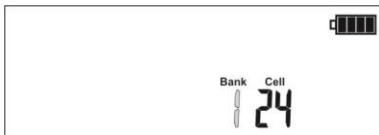

The bank number is flashing.  
To change use ▲ and ▼ buttons.

4

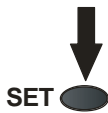

Press **SET**.  
The meter returns to the memory storing mode.

### 3.3 Viewing memory data

1

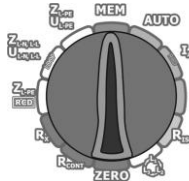

Turn on the meter.  
Turn the rotary switch to **MEM** position.

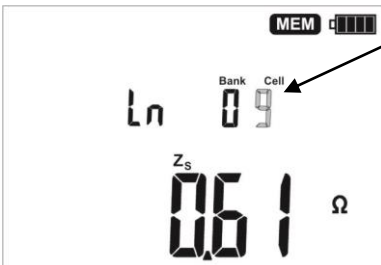















The content of the last saved cell appears.

The cell number is flashing.

To change the number of viewed data bank/cell, press **SET** button and then ▲ and ▼ buttons. If the bank or cell number is flashing - it may be changed.

The following table specifies the sequence of data storing for individual measurement results.

No.	Measurement function (result group)	Component results
1	$Z_{L-N, L-L}$	$Z_{L-N}$ or $Z_{L-L}$ or $I_K$ $R$ $X_L$ $I_K$ or $Z_{L-N}$ or $Z_{L-L}$ $U_{L-N}$
2	$Z_{L-PE}$	$Z_{L-PE}$ or $I_K$ $R$ $X_L$ $I_K$ or $Z_{L-PE}$ $U_{L-PE}$
3	$Z_{L-PE}$ <span style="border: 1px solid black; padding: 2px;">RCD</span>	$Z_{L-PE}$ <span style="border: 1px solid black; padding: 2px;">RCD</span> or $I_K$ $R$ $X_L$ $I_K$ or $Z_{L-PE}$ <span style="border: 1px solid black; padding: 2px;">RCD</span> $U_{L-PE}$
4	$R \pm 200 \text{ mA}$	$R$ $R_F$ $R_R$
5	Riso	
6	RCD	<del>Good</del> / <del>bAd</del> (for RCD AUTO) $U_B$ $R_E$ $t_A$ at $0.5I_{\Delta n}$ ,  $t_A$ at $0.5I_{\Delta n}$ ,  $t_A$ at $1I_{\Delta n}$ ,  $t_A$ at $1I_{\Delta n}$ ,  $t_A$ at $2I_{\Delta n}$ ,  $t_A$ at $2I_{\Delta n}$ ,  $t_A$ at $5I_{\Delta n}$ ,  $t_A$ at $5I_{\Delta n}$ ,  $t_{AI}$ ,  $t_{AI}$ ,  $I_A$ ,  $I_A$ ,  as above (12 lines) for pulsing current  and 

## Additional information displayed by the meter

<b>AUTO-START</b>	Measurement of $I_A$ or $I_B$ was performed using <b>RCD AUTO</b> function.
<b>L<sub>n</sub></b>	Measurement made in L-N loop for <b>Z<sub>L-N</sub></b> , <b>Z<sub>L-L</sub></b> function.
<b>LL</b>	Measurement made in the L-L loop for <b>Z<sub>L-N</sub></b> , <b>Z<sub>L-L</sub></b> function.
<b>LPE</b>	Measurement made for <b>Z<sub>L-PE</sub></b> function.
<b>LPE</b> alternating with <b>r<sub>cd</sub></b>	Measurement made for <b>Z<sub>L-PE</sub></b> <b>RCD</b> function.

### 3.4 Deleting memory data

#### 3.4.1 Deleting bank data

①

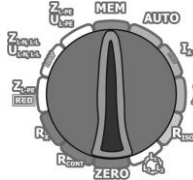

Turn on the meter.  
Turn the rotary switch to **MEM** position.

②

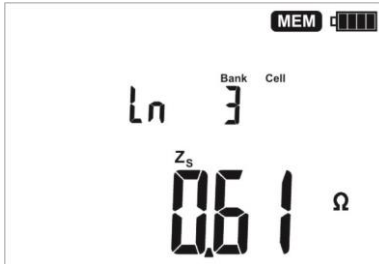

Set the bank number to be deleted acc. to section 3.2. Set the cell number before "1"...



...the cell number disappears, and appears the **del** symbol indicating the readiness to delete.

3

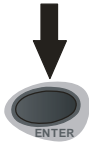

Press **ENTER** push-button.

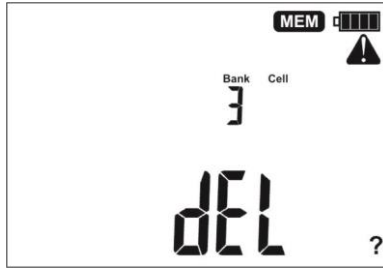

The “?” and symbols appear, asking you to confirm deletion.

4

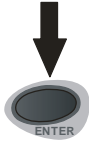

Press **ENTER** to start deleting or **ESC** to abort.

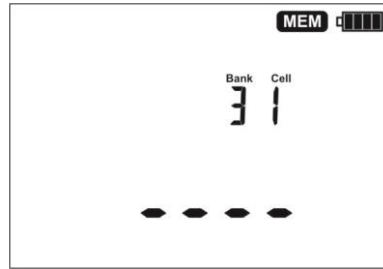

The deletion progress is shown on the display in %. When deletion is complete, the meter generates three short beeps and sets the cell number to 1.

### 3.4.2 Deleting the whole memory

1

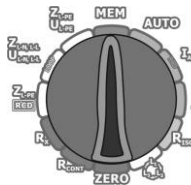

Turn on the meter.  
Turn the rotary switch to **MEM** position.

2

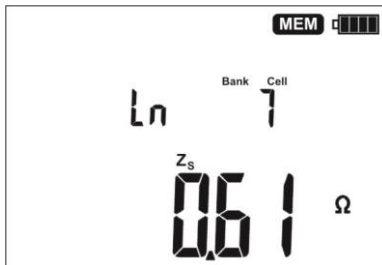

Set the bank number between “9” and “0”...

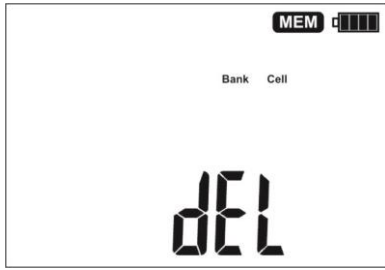

...the bank number disappears, and **del** symbol is displayed, indicating the readiness to delete.

3

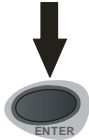

Press **ENTER** push-button.



“?” and  symbols appear, asking you to confirm deletion.

4

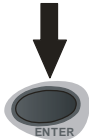

Press **ENTER** to start deleting or **ESC** to abort.

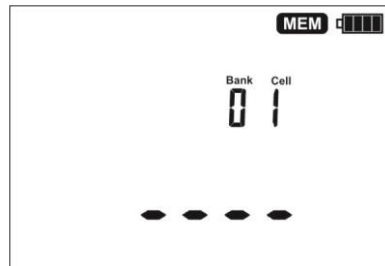

The deletion progress is shown on the display in %. When deletion is complete, the meter generates three short beeps and sets the cell number to 1.

## 3.5 Communication with a computer

### 3.5.1 Computer connection accessories

What is necessary in order to operate the meter with a computer is additional accessories, namely a cable for serial transmission and appropriate software. If this package has not been purchased along with the meter, it can be bought from the manufacturer or an authorized distributor where detailed software information is also available.

### 3.5.2 Data transmission

The meter automatically switches to data transmission mode after detecting a PC connection through a USB cable and displays the following screen.



To transmit data, follow the instructions of the software.

### 3.5.3 Software update

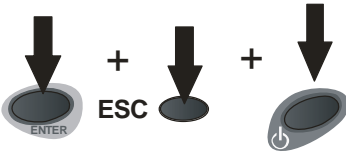

Turn on the meter, holding **ENTER** and **ESC** buttons pressed.

The meter displays the following screen.





After connecting the meter to a PC using a USB cable, follow the instructions of the software.

## 4 Troubleshooting

Before returning the meter for repair, call the service, perhaps the meter is not damaged, and the problem has occurred for another reason.

The meter repairs should be carried out only in the outlets authorized by the manufacturer.

The following table describes the recommended procedure in certain situations that occur when using the meter.

Measuring function	Symptom	Cause	Proceeding
<b>All</b>	The meter does not start after pressing button  . The symbol  is displayed during the voltage measurement. Meter turns off during the initial test.	Discharged or incorrectly placed batteries/rechargeable batteries.	Check if the batteries are placed correctly, replace and/or recharge the batteries. If this does not help, send the meter for servicing.
	Measurement errors after moving the meter from cold environment to warm and humid environment.	No acclimatization.	Do not perform the measurements until the meter reaches the ambient temperature (about 30 minutes) and dries.
<b>Fault loop and RCD</b>	Further results obtained in the same measuring point are significantly different from each other.	Incorrect connections in the tested mains.	Check the connections and remove defects.
		Mains with high noise or unstable voltage.	Perform a larger number of measurements, average the results.
<b>Fault loop</b>	The meter indicates the values close to zero or zero irrespective of the location of measurement and these values are significantly different than expected.	Incorrectly selected test leads in the meter settings.	
<b>RCD</b>	During contact voltage measurement or earth resistance, RCD is tripped (RCD is tripped already at 40% of $I_{\Delta n}$ set value).	The set value of $I_{\Delta n}$ is too high.	Set correct $I_{\Delta n}$ .
		Relatively high leakage currents in the installation.	Reduce leakage currents.
		Error in the installation.	Verify the correctness of N and PE connections.
	During the test the switch is not tripping.	The set value of $I_{\Delta n}$ is too low.	Set correct $I_{\Delta n}$ .
		Improper current waveform setting.	Set the proper current waveform.
		RCD damaged.	Test RCD by pressing TEST button, or replace RCD.
		Error in the installation.	Verify the correctness of N and PE connections.
During measurements of RCD disconnection	Tripping time is longer than the measurement time.	RCD switch should be considered as faulty.	

Measuring function	Symptom	Cause	Proceeding
	current $I_{CD}$ symbol is displayed, although the switch was tripped.		
	Large differences between the results of repeated measurements of the tripping time for the same RCD.	Initial magnetization of the transformer core inside the RCD.	It is normal for some direct-acting RCDs; try to perform further measurements with opposite polarities of differential current.
	Performing $t_A$ or $I_A$ measurement is impossible.	Touch voltage, which is generated during $t_A$ or $I_A$ measurement, may exceed the value of safe voltage - then the measurement is automatically blocked.	Check the connections of the protective conductor. Verify the selection of RCD in relation to the rated differential current.
		The set value of $I_{\Delta n}$ is too high.	Set correct $I_{\Delta n}$ .
	Unstable measurement result for $U_B$ or $R_E$ , i.e. the results of successive measurements performed at the same point of installation differ significantly from each other.	Significant leakage currents have high variability.	
	The $PE$ symbol does not appear, although the voltage between the contact electrode and <b>PE</b> conductor exceeds the detector threshold (about 50V).	Touch electrode is not functioning correctly or the meter input circuits are damaged.	Return the meter for servicing; using of a malfunctioning meter is <b>unacceptable</b> .
		Wrong position of the rotary switch.	Touch electrode is active for the measurements of the fault loop parameters and RCD, except $Z_{L-N,L-L}$ $U_{L-N,L-L}$ functions.
<b>Riso</b>	Unstable result when measuring insulation resistance.	Interferences in the measured object .	Remove the source of interferences.
		Damaged test leads.	Replace test leads.
		Leakage conductance due to surface resistances.	Apply three-lead measurement.
	The value of $R_{ISO}$ is too low when compared to the previous value obtained during the measurement on the same object performed with high current and then with lower current.	It is typical physical phenomenon: the impact of previously polarized electric dipoles in the dielectric.	Wait a few minutes and repeat the measurement.
The meter emits a continuous beep with short breaks.	The insulation of tested object is damaged, the test voltage differs from the set value by more	Terminate measurements - the insulation of tested object is damaged. If the situation repeats for	



Measuring function	Symptom	Cause	Proceeding
		than 10%.	another tested object, the meter must be serviced.
	During the measurement of insulation resistance the operation of the meter is disturbed (e.g., Auto-OFF activated too early).	The insulation of tested object is damaged: breakdowns or sparks in the object.	
	After pressing <b>START</b> button a continuous beep is generated.	The current limitation device was activated during overcharging the capacity of the tested object.	Wait a few /several seconds without interrupting the measurement.
	After completing the measurement and removing test leads from the tested object, it remains charged with dangerous voltage.	The probes were removed from the tested object before the end of the measurement.	<b>It is forbidden to disconnect test leads from the tested object before the measurement is completed.</b>
		Faulty discharge system.	If, after completing the measurement properly the object is still charged, the meter must be serviced.

## 5 Meter power supply

### 5.1 Monitoring of the power supply voltage

The charge level of the batteries or rechargeable batteries is indicated by the symbol in the right upper corner of the display on a current basis:

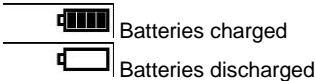

Replace or recharge the batteries!

Note:

- The **bat** symbol in the display means that the supply voltage is too low and indicates that the batteries must be replaced or recharged.
- Measurements performed with an insufficient supply voltage feature additional errors which the user is unable to evaluate.

### 5.2 Replacement of batteries

MPI-505 is powered by four R6 disposable or rechargeable batteries (alkaline batteries are recommended). The (rechargeable) batteries are placed in the compartment at the bottom of the enclosure.

**WARNING:**  
**Before replacing the batteries, disconnect the test leads from the meter.**

To replace the batteries:

1. Disconnect the leads from the measuring circuit and turn off the meter.
2. Unscrew the 3 screws and remove the battery compartment (in the bottom of the enclosure).
3. Replace all batteries. Observe the correct polarity when putting new batteries ("-" on the elastic part of the contact plate). Reverse polarity will not damage the meter or the batteries, but the meter will not work.
4. Place and bolt the battery compartment.

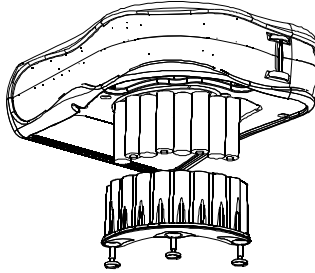

After replacement of batteries, the meter when turned on it starts in the power supply source selection mode.

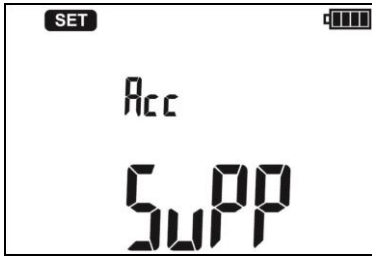

Selected power source: rechargeable batteries.



Press **SEL**  
to change the power source to batteries.



Pressing the button again will set the power source to rechargeable batteries.

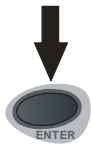

Press **ENTER** to validate the choice  
The meter goes to the measurement readiness mode.

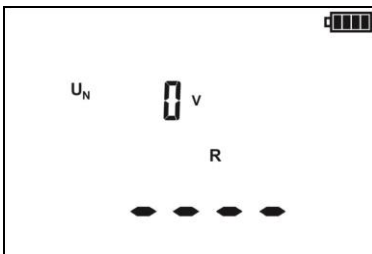

**NOTE!**

**After replacing the batteries/rechargeable batteries, always set the power supply type. The correct charge indication depends on this setting (the discharge characteristics of disposable and rechargeable batteries are different).**

**NOTE!**

**Have the meter serviced in case of battery leakage inside the compartment.**

Batteries must be recharged in an external charger.

### ***5.3 General principles regarding using Ni-MH accumulators***

- If you do not use the device for a prolonged period of time, then it is recommended to remove the accumulators and store them separately.

- Store the accumulators in a dry, cool and well ventilated place and protect them from direct sunlight. The temperature of the environment in the case of prolonged storage should not exceed 30°C. If the accumulators are stored for a long time in a high temperature, then the occurring chemical processes may reduce their lifetime.

- Accumulators NiMH resist normally 500-1000 charging cycles. The accumulators reach their maximum capacity after being formatted (2-3 charge and discharge cycles). The most important factor which influences the lifetime of an accumulator is the depth of discharge. The deeper the discharge of the accumulator, the shorter its lifetime.

- The memory effect is limited in the case of NiMH accumulator. These accumulators may be charged at any point with no serious consequences. However, it is recommended to discharge them completely every few cycles.

- During storage of Ni-MH accumulators they are discharged at the rate of approximately 30% per month. Keeping accumulators at high temperatures may accelerate this process even 100%. In order to prevent excessive discharge of accumulators, after which it would be necessary to format them, it is recommended to charge the accumulators from time to time (even if not in use).

- Modern fast chargers detect both too low and too high a temperature of accumulators and react to the situation adequately. Too low a temperature should prevent the start of the process of charging, which might damage the accumulator irreparably. An increase of the temperature of the accumulator is a signal to stop charging and is a typical phenomenon. However charging at a high temperature of the environment apart from reducing the lifetime causes an accelerated increase of the temperature of the accumulator, which will be not charged to its full capacity.

- Remember that in the case of quick charging accumulators are charged to approximately 80% of their capacity; better results may be obtained if the process of charging is continued: the charger goes then to the phase of charging with a low current and after next couple of hours the accumulators are charged to their full capacity.

- Do not charge or use accumulators in extreme temperatures. Extreme temperatures reduce the lifetime of batteries and accumulators. Avoid placing devices powered from accumulators in very hot environments. The nominal working temperature must be absolutely observed.

## 6 Cleaning and maintenance

### NOTE!

**Apply solely the maintenance methods specified by the manufacturer within the present manual.**

The casing of the meter may be cleaned with a soft, damp cloth using all-purpose detergents. Do not use any solvents or cleaning agents which might scratch the casing (powders, pastes, etc.).

Clean the probe with water and dry it. Before the probe is stored for a prolonged period of time it is recommended to grease it with any machine lubricant.

The reels and test leads should be cleaned with water and detergents, and then dried.

The electronic system of the meter does not require maintenance.

## 7 Storage

In the case of storage of the device, the following recommendations must be observed:

- Disconnect all the test leads from the meter.
- Clean the meter and all its accessories thoroughly.
- Wind the long test leads onto the reels.
- In the case the meter is to be stored for a prolonged period of time, the batteries must be removed from the device.
- In order to prevent a total discharge of the accumulators in the case of a prolonged storage, charge them from time to time.

## 8 Dismantling and utilisation

Worn-out electric and electronic equipment should be gathered selectively, i.e. it must not be placed with waste of another kind.

Worn-out electronic equipment should be sent to a collection point in accordance with the law of worn-out electric and electronic equipment.

Before the equipment is sent to a collection point, do not dismantle any elements.

Observe the local regulations concerning disposal of packages, worn-out batteries and accumulators.

## 9 Technical specifications

### 9.1 Basic data

⇒ Abbreviation "m.v" used in the specification of measurement uncertainty means a standard measured value

#### Voltage measurement

Range	Resolution	Basic uncertainty
0...440V	1 V	±(2% m.v. + 2 digits)

- Frequency range: 45...65Hz

#### Measurement of fault loop impedance $Z_{L-PE}$ , $Z_{L-N}$ , $Z_{L-L}$

##### Measurement of fault loop impedance $Z_s$

Test range according to IEC 61557:

Test lead	Test range $Z_s$
1.2 m	0.13 ... 1999 $\Omega$
5 m	0.17 ... 1999 $\Omega$
10 m	0.21 ... 1999 $\Omega$
20 m	0.29 ... 1999 $\Omega$
WS-01, WS-05	0.19 ... 1999 $\Omega$

Display range:

Display range	Resolution	Basic uncertainty
0 .. 19.99 $\Omega$	0.01 $\Omega$	±(5% m.v. + 3 digits)
20.0 ... 199.9 $\Omega$	0.1 $\Omega$	±(5% m.v. + 3 digits)
200...1999 $\Omega$	1 $\Omega$	±(5% m.v. + 3 digits)

- Rated operating voltage  $U_{nL-N}/ U_{nL-L}$ : 115/200V, 220/380V, 230/400V, 240/415V
- Operating voltage range: 100...264V (for  $Z_{L-PE}$  and  $Z_{L-N}$ ) and 100...440V (for  $Z_{L-L}$ )
- Rated mains frequency  $f_n$ : 50Hz, 60Hz
- Operating frequency range: 45...65Hz
- Maximum test current: 23A for 230V (10ms), 40A for 400V (10ms)
- Control of correctness of PE terminal connection by means of a contact electrode (applicable to  $Z_{L-PE}$ )

#### Indications of short circuit loop resistance $R_s$ and short circuit loop reactance $X_s$

Display range	Resolution	Basic uncertainty
0..19.99 $\Omega$	0.01 $\Omega$	±(5% + 5 digits) of $Z_s$ value
20.0 .. 199.9 $\Omega$	0.1 $\Omega$	±(5% + 5 digits) of $Z_s$ value

- Calculated and displayed for  $Z_s < 200\Omega$

### Indications of short-circuit current $I_k$

Test range according to IEC 61557 can be calculated on the basis of test ranges  $Z_S$  and rated voltages.

Display range	Resolution	Basic uncertainty
0.058 ... 1.999 A	0.001 A	Calculated on the basis of uncertainty for fault loop
2.00...19.99 A	0.01 A	
20,0...199.9 A	0.1 A	
200...1999 A	1 A	
2.00...19.99 kA	0,01 kA	
20.0...40.0 kA	0,1 kA	

### Measurement of fault loop impedance $Z_{L-PE}$ **RCD** (without RCD tripping)

#### Measurement of short circuit loop impedance $Z_S$

Test range according to IEC 61557: 0,5...1999 $\Omega$  for 1.2m leads, WS-01 and WS-05 and 0.51...1999 $\Omega$  for 5m, 10m and 20m leads

Display range	Resolution	Basic uncertainty
0 .. 19.99 $\Omega$	0.01 $\Omega$	$\pm(6\% \text{ m.v.} + 10 \text{ digits})$
20.0 ... 199.9 $\Omega$	0.1 $\Omega$	$\pm(6\% \text{ m.v.} + 5 \text{ digits})$
200...1999 $\Omega$	1 $\Omega$	$\pm(6\% \text{ m.v.} + 5 \text{ digits})$

- It will not trip RCD's of  $I_{\Delta n} \geq 30\text{mA}$
- Rated operating voltage  $U_n$ : 115V, 220V, 230V, 240V
- Operating voltage range: 100...264V
- Rated mains frequency  $f_n$ : 50Hz, 60Hz
- Operating frequency range: 45...65Hz
- Control of correctness of PE terminal connection by means of a touch electrode

#### Indications of short circuit loop resistance $R_s$ and short circuit loop reactance $X_s$

Display range	Resolution	Basic uncertainty
0..19.99 $\Omega$	0.01 $\Omega$	$\pm(6\% + 10 \text{ digits})$ of $Z_S$ value
20.0 .. 199.9 $\Omega$	0.1 $\Omega$	$\pm(6\% + 5 \text{ digits})$ of $Z_S$ value

- Calculated and displayed for  $Z_S < 200\Omega$

#### Indications of short-circuit current $I_k$

Test range according to IEC 61557 can be calculated on the basis of test ranges  $Z_S$  and rated voltages.

Display range	Resolution	Basic uncertainty
0.058 ... 1.999 A	0.001 A	Calculated on the basis of uncertainty for fault loop
2.00...19.99 A	0.01 A	
20,0...199.9 A	0.1 A	
200...1999 A	1 A	
2.00...19.99 kA	0,01 kA	
20.0 ... 24.0 kA	0.1 kA	

### Measurement of parameters of RCD

- Rated operating voltage  $U_n$ : 115V, 220V, 230V, 240V
- Operating voltage range: 100...264V
- Rated mains frequency  $f_n$ : 50Hz, 60Hz
- Operating frequency range: 45...65Hz

### RCD trigger and response time test $t_A$ (for measurement function $t_A$ )

Test range according to IEC 61557: 10ms ... to the upper limit of displayed value

Type of RCD	Setting of multiple values	Test range	Resolution	Basic uncertainty
General type	0.5 $I_{\Delta n}$	0..300 ms	1 ms	$\pm 2\%$ m.v. $\pm 2$ digits <sup>1)</sup>
	1 $I_{\Delta n}$			
	2 $I_{\Delta n}$	0..150 ms		
	5 $I_{\Delta n}$	0..40 ms		
Selective	0.5 $I_{\Delta n}$	0..500 ms		
	1 $I_{\Delta n}$			
	2 $I_{\Delta n}$	0..200 ms		
	5 $I_{\Delta n}$	0..150 ms		









<sup>1)</sup> for  $I_{\Delta n} = 10$  mA and 0.5  $I_{\Delta n}$  uncertainty is  $\pm 2\%$  m.v.  $\pm 3$  digits

- Accuracy of differential current setting:

for 1\* $I_{\Delta n}$ , 2\* $I_{\Delta n}$  and 5\* $I_{\Delta n}$  ..... 0..8%

for 0.5\* $I_{\Delta n}$  ..... -8..0%

### Effective value of forced leakage current at measurement of RCD disconnection time

$I_{\Delta n}$	Multiplication factor setting							
	0.5		1		2		5	
								
10	5	3.5	10	20	20	40	50	100
30	15	10.5	30	42	60	84	150	212
100	50	35	100	141	200	282	500	707
300	150	105	300	424	600	848	—	—
500	250	175	500	707	1000	—	—	—
1000	500	350	1000	—	—	—	—	—

### Measurement of resistance-to-earth $R_E$

Selected nominal current of switch	Test range	Resolution	Test current	Basic uncertainty
10 mA	0.01k $\Omega$ ..5.00 k $\Omega$	0.01 k $\Omega$	4 mA	0..+10% m.v. $\pm 8$ digits
30 mA	0.01k $\Omega$ ..1.66k $\Omega$		12 mA	0..+10% m.v. $\pm 5$ digits
100 mA	1 $\Omega$ ..500 $\Omega$	1 $\Omega$	40 mA	0..+5% m.v. $\pm 5$ digits
300 mA	1 $\Omega$ ..166 $\Omega$		120 mA	
500 mA	1 $\Omega$ ..100 $\Omega$		200 mA	
1000 mA	1 $\Omega$ ..50 $\Omega$		400 mA	

### Measurement of contact voltage $U_B$ in relation to nominal differential current

Test range according to IEC 61557: 10...50V

Test range	Resolution	Test current	Basic uncertainty
0..9.9V	0.1 V	0.4 x $I_{\Delta n}$	0..10% m.v. $\pm 5$ digits
10.0 .. 50.0 V			0..15% m.v.



### Measurement of RCD disconnection current $I_A$ for sinusoidal differential current

Test range according to IEC 61557:  $(0.3...1.0)I_{\Delta n}$

Selected nominal current of RCD	Test range	Resolution	Test current	Basic uncertainty
10 mA	3.0..10.0 mA	0.1 mA	$0.3 \times I_{\Delta n}..1.0 \times I_{\Delta n}$	$\pm 5 \% I_{\Delta n}$
30 mA	9.0 .. 30.0 mA			
100 mA	30..100 mA			
300 mA	90..300 mA	1 mA		
500 mA	150..500 mA			
1000 mA	300..1000 mA			

- it is possible to start the measurement from the positive or the negative half-period of forced leakage current
- test current passage time..... max. 3200 ms

### Measurement of RCD disconnection current $I_A$ for unidirectional differential pulsed current

Test range according to IEC 61557:  $(0.4...1.4)I_{\Delta n}$  for  $I_{\Delta n} \geq 30\text{mA}$  and  $(0.4...2)I_{\Delta n}$  for  $I_{\Delta n} = 10\text{mA}$

Selected nominal current of RCD	Test range	Resolution	Test current	Basic uncertainty
10 mA	4.0..20.0 mA	0.1 mA	$0.35 \times I_{\Delta n}..2.0 \times I_{\Delta n}$	$\pm 10 \% I_{\Delta n}$
30 mA	12.0..42.0 mA			
100 mA	40..140 mA	1 mA	$0.35 \times I_{\Delta n}..1.4 \times I_{\Delta n}$	$\pm 10 \% I_{\Delta n}$
300 mA	120..420 mA			
500 mA	200..700 mA			

- measurement may be performed for positive or negative half-periods of forced leakage current
- test current passage time..... max. 3200 ms

### Low-voltage continuity and resistance measurement

#### Measurement of continuity of protective conductors and equipotential bondings with $\pm 200$ mA current

Measurement range according to IEC 61557-4: $\Omega$

Range	Resolution	Basic uncertainty
0.00 ... 19.99 $\Omega$	0.01 $\Omega$	$\pm(2\% \text{ m.v.} + 3 \text{ digits})$
20.0 ... 199.9 $\Omega$	0.1 $\Omega$	
200...400 $\Omega$	1 $\Omega$	

- Voltage at open terminals: 4...9V
- Output current at  $R < 2\Omega$ : min 200mA ( $I_{SC}$ : 200...250mA)
- Compensation of test leads resistance
- Measurements for both current polarizations

#### Measurement of resistance with low current

Range	Resolution	Basic uncertainty
0.0 ... 199.9 $\Omega$	0.1 $\Omega$	$\pm(3\% \text{ m.v.} + 3 \text{ digits})$
200...1999 $\Omega$	1 $\Omega$	

- Voltage at open terminals: 4...9V
- Short-circuit current  $I_{SC}$ : 7mA
- Audio signal for measured resistance  $< 30\Omega \pm 50\%$
- Compensation of test leads resistance

## Measurement of insulation resistance

Test range according to IEC 61557-2 for  $U_N = 100V$ : 100k $\Omega$ ...500M $\Omega$

Display range for $U_N = 100 V$	Resolution	Basic uncertainty
0...1999 k $\Omega$	1 k $\Omega$	± (3 % m.v. + 8 digits)
2.00...19.99 M $\Omega$	0.01 M $\Omega$	
20.0...199.9 M $\Omega$	0.1 M $\Omega$	
200...500 M $\Omega$	1 M $\Omega$	

Test range according to IEC 61557-2 for  $U_N = 250V$ : 250k $\Omega$ ...1000M $\Omega$

Display range for $U_N = 250 V$	Resolution	Basic uncertainty
0...1999 k $\Omega$	1 k $\Omega$	± (3 % m.v. + 8 digits)
2.00...19.99 M $\Omega$	0.01 M $\Omega$	
20.0...199.9 M $\Omega$	0.1 M $\Omega$	
200...1000M $\Omega$	1 M $\Omega$	

Test range according to IEC 61557-2 for  $U_N = 500V$ : 500k $\Omega$ ...1999M $\Omega$

Display range for $U_N = 500 V$	Resolution	Basic uncertainty
0...1999 k $\Omega$	1 k $\Omega$	± (3 % m.v. + 8 digits)
2.00...19.99 M $\Omega$	0.01 M $\Omega$	
20.0...199.9 M $\Omega$	0.1 M $\Omega$	
200...1999M $\Omega$	1 M $\Omega$	

Test range according to IEC 61557-2 for  $U_N = 1000V$ : 1000k $\Omega$ ...3.00G $\Omega$

Display range for $U_N = 1000 V$	Resolution	Basic uncertainty
0...1999 k $\Omega$	1 k $\Omega$	± (3 % m.v. + 8 digits)
2.00...19.99 M $\Omega$	0.01 M $\Omega$	
20.0...199.9 M $\Omega$	0.1 M $\Omega$	
200...1999M $\Omega$	1 M $\Omega$	
2.00 ... 3.00 G $\Omega$	0.01 G $\Omega$	± (4 % m.v. + 6 digits)

- Test voltage: 100V, 250V, 500V and 1000V
- Accuracy of generated voltage (Robc [ $\Omega$ ]  $\geq 1000 \cdot U_N$  [V]): -0+10% from the set value
- Detection of a dangerous voltage before commencing a measurement
- Discharging the object tested
- Measurement of voltage on terminals +R<sub>ISO</sub>, -R<sub>ISO</sub> within the range of 0..440V
- Test current < 2mA

## Phase sequence

- Phase sequence indication: compatible, incompatible
- Range of mains voltage  $U_{L-L}$ : 100...440V (45...65Hz)
- Display of phase-to-phase voltages

## Other technical specifications

- a) type of insulation ..... double, EN 61010-1 and IEC 61557 compliant
- b) measurement category ..... IV 300V (III 600V) wg EN 61010-1
- c) degree of protection of enclosure acc. to EN 60529 ..... IP54
- d) meter power supply ..... LR6 alkaline batteries or NiMH rechargeable batteries size AA (4 pcs)

- e) dimensions ..... 260x190x60 mm
- f) meter weight ..... about 2.2 kg
- g) storage temperature ..... -20...+60°C
- h) operating temperature ..... 0...+40°C
- i) humidity ..... 20...90%
- j) reference temperature ..... +23 ± 2°C
- k) reference humidity ..... 40...60%
- l) altitude (above sea level) ..... <2000 m
- m) time to Auto-OFF ..... 120 seconds
- n) number of measurements Z or RCD (for Panasonic POWERMAX 3 alkaline batteries) ..... >3000 (2 measurements per minute)
- o) number of measurements R<sub>ISO</sub> or R (for Panasonic POWERMAX 3 alkaline batteries) ..... >2000
- p) display ..... modular LCD
- q) memory of measurement results ..... 990 cells, 3500 entries
- r) data transmission ..... USB
- s) quality, design and manufacturing are ..... ISO 9001 compliant
- t) the device meets the requirements of IEC 61557 standard
- u) the product meets EMC requirements (immunity for industrial environment) according to the following standards ..... EN 61326-1:2006 and EN 61326-2-2:2006

## 9.2 Additional data

Data on additional uncertainties are useful mainly when the meter is used in non-standard conditions and for metrological laboratories for the purpose of calibration.

### 9.2.1 Additional uncertainties according to IEC 61557-2 (R<sub>ISO</sub>)

Significant parameter	Designation	Additional uncertainty
Position	E <sub>1</sub>	0%
Supply voltage	E <sub>2</sub>	0% ( <b>BAT</b> is not lit)
Temperature 0...35°C	E <sub>3</sub>	2%

### 9.2.2 Additional uncertainties according to IEC 61557-3 (Z)

Significant parameter	Designation	Additional uncertainty
Position	E <sub>1</sub>	0%
Supply voltage	E <sub>2</sub>	0% ( <b>BAT</b> is not lit)
Temperature 0...35°C	E <sub>3</sub>	1.2 m lead – 0Ω 5 m lead – 0.011Ω 10 m lead – 0.019Ω 20 m lead – 0.035Ω WS-01, WS-04 leads – 0.015Ω
Phase angle 0..30° at the bottom of test range	E <sub>6.2</sub>	0.6%
Frequency 99%..101%	E <sub>7</sub>	0%
Network voltage 85%..110%	E <sub>8</sub>	0%
Harmonic	E <sub>9</sub>	0%
DC component	E <sub>10</sub>	0%

### 9.2.3 Additional uncertainties according to IEC 61557-4 (R ±200mA)

Significant parameter	Designation	Additional uncertainty
Position	E <sub>1</sub>	0%
Supply voltage	E <sub>2</sub>	0.5% ( <b>BAT</b> is not lit)
Temperature 0...35°C	E <sub>3</sub>	1.5%

### 9.2.4 Resistance of voltage electrode Rs[Ω] additional uncertainties according to IEC 61557-6 (RCD)

I<sub>A</sub>, t<sub>A</sub>, U<sub>B</sub>

Significant parameter	Designation	Additional uncertainty
Position	E <sub>1</sub>	0%
Supply voltage	E <sub>2</sub>	0% ( <b>BAT</b> is not lit)
Temperature 0...35°C	E <sub>3</sub>	0%
Resistance of electrodes	E <sub>5</sub>	0%
Network voltage 85%..110%	E <sub>8</sub>	0%

## 10 Equipment

### 10.1 Standard equipment

Standard set of equipment supplied by the manufacturer includes:

- MPI-505 meter – **WMPLMPI505**
- set of test leads:
  - adapter WS-01 with UNI-SCHUKO plug (CAT III 300V) and buttons to trigger the measurement and enter the measurement results into the memory – **WAADAWS01**
  - leads 1,2m with banana plugs – 3 pcs (yellow **WAPRZ1X2YEBB**, red- **WAPRZ1X2REBB** and blue - **WAPRZ1X2BUBB**)
  - USB interface cable - **WAPRZUSB**
- accessories
  - crocodile clip – 2 clips (yellow K02 – **WAKROYE20K02** and red – **WAKRORE20K07**)
  - test prod with banana socket – 3 pcs (yellow– **WASONYEOGB1**, red – **WASONREOGB1** and blue – **WASONBUOGB1**)
- case L-4 – **WAFUTL4**
- meter harness – **WAPOZSZE2**
- OPERATING MANUAL
- operating manual
- calibration certificate
- Four LR6 alkaline batteries

### 10.2 Optional accessories

Additionally, the following items that are not included in the scope of standard equipment can be purchased from the manufacturer or the distributors:

- red test leads with banana plugs:
  - length 5m – **WAPRZ005REBB**
  - length: 10m – **WAPRZ010REBB**
  - length: 20m – **WAPRZ020REBB**
- adapter WS-05 with UNI-Schuko plug – **WAADAWS05**
- AGT-16C adapter for three-phase, four-contact sockets – **WAADAAGT16C**
- AGT-16P adapter for three-phase, five-contact sockets– **WAADAAGT16P**

- AGT-16T adapter for single-phase industrial sockets – **WAADAAGT16T**
- AGT-32C adapter for three-phase, four-contact sockets – **WAADAAGT32C**
- AGT-32P adapter for three-phase, five-contact sockets – **WAADAAGT32P**
- AGT-32T adapter for single-phase industrial sockets – **WAADAAGT32T**
- AGT-63P adapter for three-phase, five-contact sockets – **WAADAAGT63P**
- RCD testing adapter TWR-1J – **WAADATWR1J**
- "SONEL Pomiary Elektryczne" ( SONEL Electrical Measurements) - software for generating measurement reports - **WAPROSONPE4**
- software for creating drawings, electrical installation diagrams "SONEL PE Schematic"- **WAPROSCHEM**
- software for creating measurement calculations "SONEL PE Kalkulacje" (SONEL Calculations) - **WAPROKALK**
- calibration certificate

## 11 Manufacturer

The manufacturer of the device, which also provides guarantee and post-guarantee service is the following company:

**SONEL S.A.**  
 ul. Wokulskiego 11  
 58-100 Świdnica  
 Poland  
 tel. +48 74 858 38 60  
 fax +48 74 858 38 09  
 E-mail: [export@sonel.pl](mailto:export@sonel.pl)  
 Web page: [www.sonel.pl](http://www.sonel.pl)

**Attention:**  
**Service repairs must be realised solely by the manufacturer.**



**MPI-525**  
Multifunction Electrical  
Installations Meter



**MPI-505**  
Multifunction  
Electrical  
Installations  
Meter



**MPI-502**  
Multifunction  
Electrical  
Installations  
Meter



**MRU-200**  
Earth Resistance  
and Resistivity Meter

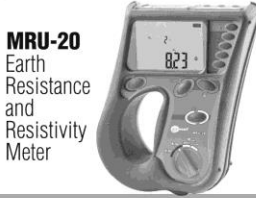

**MRU-20**  
Earth  
Resistance  
and  
Resistivity  
Meter



**MIC-2510**  
Insulation  
Resistance  
Meter



**MIC-2**  
Insulation  
Resistance  
Meter



**KT-384**  
Thermal  
imager



**MIC-30**  
Insulation  
Resistance  
Meter

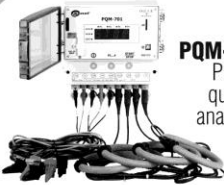

**PQM-701**  
Power  
quality  
analyzer

**LXP-1**  
Datalogging  
Light  
Meter



**PAT-805**  
Portable  
appliance  
tester

**CMM-40**  
Industrial  
multimeter



**CMP-1006**  
Digital  
Clamp-on  
multimeter

**MMR-630**  
Microohmmeters



**CMP-200**  
Digital  
Clamp-on  
AC

**DIT-500**  
IR thermometer









**LKZ-700**  
Wire tracer

# WARNINGS AND GENERAL INFORMATION DISPLAYED BY THE METER

## NOTE!

MPI-505 meter is designed to operate at the rated phase voltages 115V, 220V, 230V and 240V and phase-to-phase voltages 200V, 380V, 400V and 415V. Connecting voltage higher than allowed between any of the test terminals may damage the meter and cause a hazard to the user.

<p>&gt; <math>440^u</math> V and  and continuous beep</p>	<p>Voltage supplied to the meter exceeds 440V. <b>Immediately disconnect the meter from the mains!</b></p>
<p>PE and  and continuous beep</p>	<p>Incorrect connection of PE conductor (after the touch electrode has been touched). If the symbol does not appear, even when the voltage between the touch electrode and PE conductor exceeds the detector triggering threshold (approximately 50V), the meter must be returned for servicing; using a faulty meter is <b>not allowed</b>. Touch electrode is active for the measurements of the fault loop parameters and RCD, except <math>Z_{L-N,L-L}</math> <math>U_{L-N,L-L}</math> functions.</p>
<p></p>	<p>Measurement blocked by the thermal protection. Long beep after pressing <b>START</b> button.</p>
<p></p>	<p>Measuring range is exceeded.</p>
<p></p>	<p>Mains frequency is outside the acceptable limits (45 .. 65Hz).</p>
<p></p>	<p>Status of the batteries/rechargeable batteries: Batteries/rechargeable batteries charged, Batteries/rechargeable batteries discharged. After replacing batteries/rechargeable batteries set the type of power supply, as this setting influences the correct indication of the charging status (discharging characteristics of batteries and rechargeable batteries are different).</p>
<p>bAt (on the main field)</p>	<p>Discharged batteries or rechargeable batteries do not allow for stable operation of the meter. Replace or recharge the batteries.</p>
<p>SUPP Acc bAt (on the additional field)</p>	<p>Power supply type (after replacing the batteries/rechargeable batteries): Supply type: rechargeable batteries. Supply type: disposable batteries.</p>
<p>USB (on the additional field) </p>	<p>USB connection is in use: Data transfer via USB, Software update mode (via USB).</p>



**SONEL S.A.**  
Wokulskiego 11, St  
58-100 Swidnica  
Poland



+48 74 85 83 860  
+48 74 85 83 800  
fax +48 74 85 83 809

<http://www.sonel.pl>  
e-mail: [export@sonel.pl](mailto:export@sonel.pl)